

# DUX WATER HEATERS

HOT WATER SOLUTIONS PRODUCT GUIDE



# AN ICONIC BRAND

An iconic Australian brand since 1915, Dux is committed to producing high quality water heaters and to the on-going development of new products for the Australian market.

Dux water heaters are manufactured in a state-of-the-art facility in regional NSW, using a Quality Endorsed Company production system. This assures that customers have purchased the highest quality water heater available.

Dux is proudly owned by Noritz, an international hot water powerhouse and a leading Japanese manufacturer of residential and commercial water heaters.



## BEFORE YOU MAKE A DECISION ABOUT WHICH HOT WATER SYSTEM IS RIGHT, CONSIDER THESE...

### Running out of hot water?

Growing families, teenagers and an inadequate hot water system don't mix! If you're running out of hot water, you may need to consider installing a larger one.

### How to choose the right tariff for your electric water heater

Most energy companies offer cheaper concessional rate tariffs for use with electric water heaters. These "off-peak" tariffs supply electricity during select periods during the night and/or day. This can be a great way to save on your electricity bills when coupled with a large volume storage tank to supply enough hot water for your home inbetween heating periods.

Speak to your energy company regarding tariff availability.

### Natural gas or electricity?

Already have a natural gas connection? If you are using natural gas for cooking and room heating, it makes sense to use natural gas for your hot water. There is a choice of gas storage, continuous flow and gas boosted solar models to choose from.

If natural gas is not available where you live, there is a wide selection of electric storage, heat pump and electric boosted solar water heaters available.

You may also have the option of installing bottled gas (LPG). Speak to an LPG bottle supplier in your local area e.g. Elgas.

### Gas storage or continuous flow?

When deciding between continuous flow or a storage tank, it's important to think about how you use hot water.

Continuous flow water heaters are compact in size and very energy efficient. You'll never run out of hot water. These models require access to larger gas lines and power.

Gas storage will provide consistent pressure and water temperatures, for an enjoyable shower experience and minimal wait time for hot water. Suits a standard gas line and doesn't require power.

### Indoor or outdoor?

Most gas water heaters are installed outside, whilst electric storage provides flexibility to install inside or outside.

Continuous flow are an ideal compact choice when installing outside as they free up valuable space.

### Can your water heater keep up?

If you have more than one shower head or double basin with taps in your bathroom, then a storage tank provides a hot and strong flow of water, at mains pressure, to more than one tap or shower at a time, without annoying pressure fluctuations.

If opting for a continuous flow water heater in this situation, choose a higher flow rate model capable of servicing multiple outlets at the same time.



# proflo® for homes of all sizes

TOUGH BUT STYLISH HOT WATER SYSTEMS THAT WILL GO THE DISTANCE.

If you're looking to replace an existing electric storage water heater, Proflo is an ideal solution - available in a variety of tank sizes for homes of all sizes and delivering full mains pressure.

## PROFLO 25L & 50L

- Proflo 50L now boasts a compact 670mm height, making it an easier fit into tight cupboards whilst still delivering 50L of hot water
- V-Fit plumbing connections provide better access for installation
- Made in a Noritz manufacturing facility
- 7 years tank warranty, 1 year parts and labour\*

## PROFLO 80L - 400L

- 80L - 400L Proflo water heaters now boast a larger anode to increase tank life
- Features durable Y class commercial grade enamel
- Hard-wearing, tough polymer base resists damage and is rust-proof
- Feature 50mm thick, dense foam insulation for less heat loss and lower running costs
- Made in Australia
- 10 years tank warranty, 1 year parts and labour\*

## RANGE FEATURES

- Easy installation, water connections on both sides of the tank
- Screwless tank lids offer a cleaner appearance and are safer too
- Low maintenance and long service life
- Full flow pressure to all outlets
- Can be installed indoors or out#

CAPACITY	NO. OF ADULTS & CHILDREN	
	Continuous Tariff	Off Peak
25L	1 Adult	
50L	2 Adults	
80L	3 Adults	
125L	4 Adults	
160L	5 Adults	3 Adults
250L	7 Adults	5 Adults
315L	8 Adults	6 Adults
400L	10 Adults	8 Adults

Adult icon can represent dishwasher or washing machine.  
 Continuous Tariff; Provides power so that your water can be heated at any time of the day or night.  
 Off Peak; Generally only provides power for your water heater for between 6-12 hours a night - check with your local electricity retailer for details of off-peak hours.  
 #Plug in models can only be installed indoors.



SO MANY SIZES FOR HOT WATER YOU CAN'T GO WRONG.

# prodigy<sup>®</sup> 4 & 5 star gas storage

NO EXTRA SPACE NEEDED TO INSTALL AN EFFICIENT PRODUCT.

Gas storage hot water systems give you full mains pressure with a constant, strong stream of hot water.

If you're looking to replace an existing gas storage water heater, Dux Prodigy is an ideal solution. The range consists of both 4 and 5 star models that feature identical dimensions as each other and older 3 star models, allowing easy replacement with higher efficiency models.

## PRODIGY 4 STAR

- Market leader in hot water recovery and first hour capacity†
- Now matches the first hour capacity of the old 3 star models
- 7 years tank warranty, 1 year parts and labour\*

## PRODIGY 5 STAR

- Easy installation, with water connections on both sides of the tank
- Patented flue damper design reduces heat loss
- 10 years tank warranty, 1 year parts and labour\*

## RANGE FEATURES

- New burner technology means faster recovery rates and more hot water when you need it
- Identical footprint with existing 3 star gas storage unit, ensuring easy replacement
- Mains pressure hot water
- Inline foam filled provides better insulation and a more robust design
- No power point required so hot water continues, even with no power
- Operates on a standard size 1/2" gas line
- Available in both natural gas and propane (LPG) models
- Made in Australia

Both Prodigy 4 and 5 star gas storage models feature the same footprint as existing 3 star gas storage water heaters, allowing easy replacement of older systems.



FIRST HOUR CAPACITY	STORAGE CAPACITY	RECOVERY RATE (L/hr)	FIRST HOUR CAPACITY
Prodigy 4 & 5	135L	130L	265L
Prodigy 4 & 5	170L	146L	316L

	CAPACITY (L)	PEOPLE	
<b>prodigy</b>	135		3-6
<b>prodigy</b>	170		4-7

Adult icon can represent dishwasher or washing machine.

NEW AND IMPROVED TECHNOLOGY  
MAKES THE DIFFERENCE

† In the 4 star gas storage class.



PRODIGY 4 STAR



135L

170L

PRODIGY 5 STAR



135L

170L

# gas continuous flow

**INSTANT HOT WATER, HEATING WATER ONLY AS IT'S NEEDED.**

Compact and efficient, Dux's latest range of Continuous Flow units are an excellent option for Australian homes. Dux gas continuous flow water heaters heat the water only as needed, not wasting energy by keeping water in a tank hot, earning it a 6 star (or higher) energy rating.

With several continuous flow capacity models available, ensure you select a the water heater that best suits to the number of outlets in the home.

- 6 star or higher energy rating
- Never runs out of hot water
- Condensing models deliver over \$1000<sup>#</sup> savings over the 12 year warranted life of the heat exchanger
- Features superior condensing technology that boasts over 90% thermal efficiency by capturing additional heat in the secondary heat exchanger
- Superior technology straight from Noritz, a leading Japanese manufacturer of continuous flow water heaters, selling over 2 million water heaters per annum
- Smallest domestic condensing gas water heater
- Electronic ignition means no standby pilot light
- Available in natural gas and propane (LPG) models
- 12 year warranty on heat exchanger, including 3 year full parts and labour\*



SAVES OVER  
**\$1000<sup>#</sup>**



SIZING	MODELS		
	17L/min	21L/min	26L/min
No. of Outlets	2	2-3	3

## ACCESSORIES



Accessories include separate controllers that allow you to select the hot water temperature you prefer – a welcome safety feature for families.

Optional accessories for Dux Continuous Flow water heaters include:

- Pipe cover (CF-H33-K600)
- Recess boxes (RBM3)
- Anti-theft kit (H1210)
- Flue diverters (see spec pages for part number)

## HOT WATER ON DEMAND WHEN YOU NEED IT

#Condensing running cost savings compared to a 5 star natural gas storage water heater over the 12 year warranty of the heat exchanger.

### CONDENSING

Water is heated a second time using the heat from the exhaust gas, reducing wasted energy and lowering the exhaust temperature.

EXHAUST TEMPERATURE IS  
**ONLY 50°C**

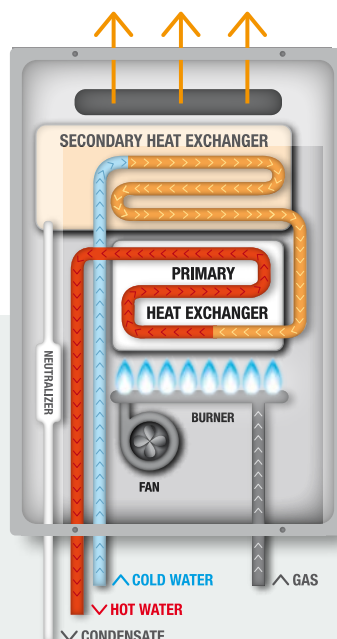

(Condensing technology)  
Thermal efficiency = 90-96%

### NON-CONDENSING

Water only passes through one heat exchanger and the energy from the exhaust gas is wasted.

EXHAUST TEMPERATURE IS  
**APPROX 200°C**

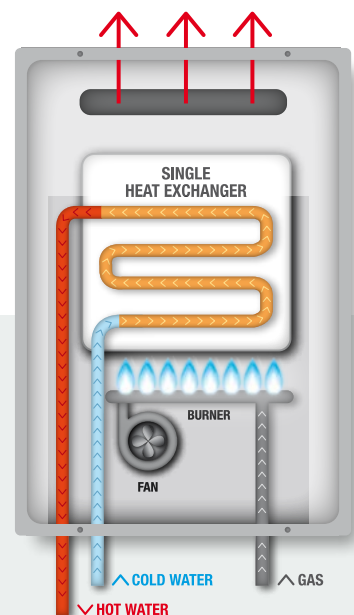

(Conventional technology)  
Thermal efficiency = 80-84%



# airoheat® *air-sourced heat pump*

**POWERFUL, EFFICIENT AND ENVIRONMENTALLY FRIENDLY.**

If your home doesn't offer suitable roof space and orientation for installing solar collectors, Airoheat is the next best choice in environmentally friendly water heaters, without the need for solar panels.

Working like a refrigerator but in reverse, it takes air in from outside the tank and uses it to heat water. Its patented in-tank heating coil ensures direct heat transfer, eliminating exposure to heat loss issues often associated with other styles of heat pump.

- Single piece design allows for faster installation
- Composite condensation tray is designed for rapid drainage in high rainfall areas
- Dual anodes provide greater protection against tank corrosion
- Patented in-tank heating coil to improve heat transfer
- Improved thermal efficiency minimises heat loss due to a fully insulated storage tank and a robust refrigeration system
- Water connections on both sides of tank provide easy installation
- Eligible for Small-scale technology certificates
- 5-year tank warranty, 2-year refrigerant components, 1-year full parts and labour\*



airoheat® heatpump		
CAPACITY (L)	PEOPLE	
250		3-5

Adult icon can represent dishwasher or washing machine.

PRODUCT CODE: D2FHG4HW0C	STC ZONE*				
	1	2	3	4	5†
250L HEAT PUMP	22	21	26	27	27†



†Refer to [www.dux.com.au/zones](http://www.dux.com.au/zones) for postcodes in Zone 5.

STC values are subject to change without notice and are correct at time of printing. STCs calculations are based on continuous tariff. Size figures are based on environmental averages which can effect the performance of solar and heat pump heaters. Adult icon can represent dishwasher or washing machine. Based on connection to continuous tariff.

**AUSTRALIA'S MOST HIGHLY AWARDED ENVIRONMENTAL WATER HEATER**

# sunpro® *free energy from the sun*

## OUTSTANDING EFFICIENCY TO HELP REDUCE ENERGY BILLS.

If you're aiming to reduce your carbon footprint, choose a Sunpro solar water heater. Sunpro uses the sun's energy to heat water via solar panels. Comes with either an electric or gas booster ensuring hot water on cloudy days or in times of high demand.

Sunpro will save you money on energy bills, providing an economical, sustainable hot water solution for years to come.

- Next generation split system design provides flexible installation locations without the need for expensive roof reinforcement
- Available in electric or gas boosted models
- Multi-temperature sensors on a vitreous enamel tank configuration enable optimum solar gain while reducing the risk of overheating
- High performance collectors ensure efficient transfer of heat to water
- Patented Hotlogic® processor maximises energy from the sun
- Efficient, polyurethane insulated storage tank
- Supplies mains pressure hot water
- Eligible for Small-scale technology certificates
- 5-year tank and panel warranty, 1-year parts and labour\*



	CAPACITY (L)	PEOPLE
<b>electric sunpro®</b>	250	2-4
<b>electric sunpro®</b>	315	3-5
<b>electric sunpro®</b>	400	4-7
<b>gas sunpro®</b>	315	2-6

Adult icon can represent dishwasher or washing machine.

sunpro® solar			STC ZONE*			
		COLLECTORS	1	2	3	4
250L	D2F136T2AC	2	38	41	36	32
315L	D3F136T2AC	2	38	42	37	32
400L	D4F136T3AC	3	44	45	45	40
315L	DN15DT2DC/ DL15DT2DC	2	38	42	35	30



### DID YOU KNOW...

Dux® solar water heaters are supplied with a genuine Reliance® brand Dux® Solar tempering valve adjusted to Dux® specifications to ensure maximum hot water delivery.

STC values are subject to change without notice and are correct at time of printing. STCs calculations are based on continuous tariff. Size figures are based on environmental averages which can effect the performance of solar and heat pump heaters. Adult icon can represent dishwasher or washing machine. Based on connection to continuous tariff.

## INVIGORATING HOT WATER IN ANY KIND OF WEATHER

# PROFLO® ELECTRIC STORAGE

## proflo small electric

SPECIFICATIONS	25S124P^	25S1	50S124P^	50S1
Storage Capacity (L)	31	31	50	50
Hot Water Delivery (L)	25	25	50	50
Net Weight Empty (kg)	17	17	23	23
Element Sizes (kW)	2.4	2.4, 3.6	2.4	2.4, 3.6
Relief Valve Pressure (kPa)	1000	1000	1000	1000
Max Inlet Pressure (kPa)	800	800	800	800

^ Proflo Plug-in model (plugs into standard power point)

### TANK DIMENSIONS (MM)

	25L	50L
A Overall Height	455	670
B Overall Diameter	405	405
C Hot Water Outlet	275	490
D Cold Water Inlet	145	145
E Electrical Entry	70	70

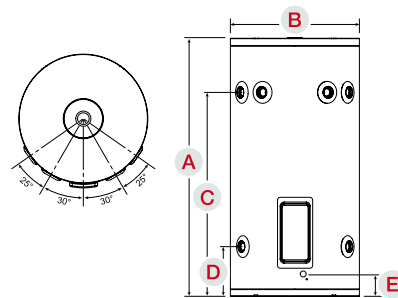

## proflo large electric

SPECIFICATIONS	80T1	125X1 NARROW DIAMETER	125T1	160T1	250T1	315T1	315T2 TWIN ELEMENT	400T1	400T2 TWIN ELEMENT
Storage Capacity (L)	88	132	130	161	259	321	321	415	415
Hot Water Delivery Rating (L)	80	125	125	160	250	315	315	400	400
Twin Element Boost Capacity (L)	-	-	-	-	-	-	50	-	80
Element Sizes (kW)	1.8, 2.4, 3.6	1.8, 3.6	1.8, 3.6	2.4, 3.6	3.6	3.6	2 x 3.6 or 2 x 4.8	3.6	2 x 3.6
Net Weight Empty (kg)	41	54	51	59	72	93	93	115	115
Relief Valve Pressure (kPa)	1400	1400	1400	1400	1000	1000	1000	1000	1000
Max Inlet Pressure (kPa)	1120	1120	1120	1120	800	800	800	800	800

All Dux proflo water heaters are dual-handed for ease of installation and operate at 240V AC single phase electricity supply.

### TANK DIMENSIONS

	80L	125L NARROW DIAMETER	125L	160L	250L	315L	400L
A Overall Height (mm)	925	1300	1090	1315	1445	1765	1705
B Overall Diameter (mm)	490	490	530	530	620	620	705
C Cold Water Inlet (mm)	160	160	190	190	195	195	220
D Hot Water Outlet (mm)	735	1115	865	1095	1210	1530	1445

#### 125L NARROW DIAMETER SPECIFICATIONS

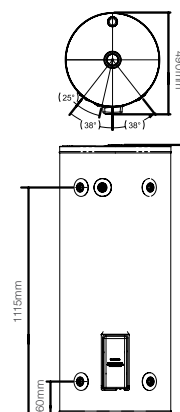

#### 80L - 400L STANDARD MODELS

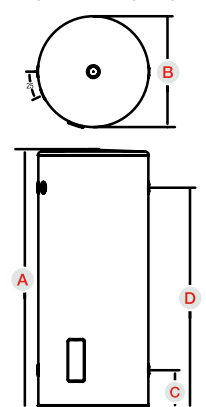



# PRODIGY® GAS STORAGE

SPECIFICATIONS	prodigy®5		prodigy®4	
	135DB5N/135DB5P	170DB5N/170DB5P	135ZB4N/135ZB4P	170ZB4N/170ZB4P
Nominal Capacity (L)	135	170	135	170
Net Weight Empty (kg)	73	87	72	86
Relief Valve Pressure (kPa)	1400	1400	1400	1400
Gas Consumption (Propane) (MJ/h)	28	32	28	32
Gas Consumption (NG) (MJ/h)	29.5	33.5	29.5	33.5
Energy Star Rating	5.3	5.3	4.5	4.2

TANK DIMENSIONS (MM)				
A Overall Height Outdoor	1600	1900	1600	1900
B Hot Water Outlet	1325	1620	1325	1620
C Cold Water Inlet	220	220	220	220
D Gas Inlet	300	300	300	300

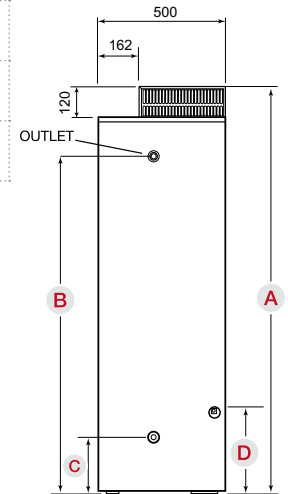

# AIROHEAT® HEAT PUMP SYSTEM

SPECIFICATIONS	airoheat®
	D2FHG4HW0C
Storage Capacity (L)	250
Net Weight Empty (kg)	107
Power Consumption (General Tariff - kW)	1.2
Max Water Supply Pressure (kPa)	800
Relief Valve Pressure (kPa)	1000
Rated Voltage	240V ac

Not suitable for installation in alpine areas or areas above 1000m.

TANK DIMENSIONS (MM)	
A System Height	1710
B System Width	660
C Inlet	195
D Outlet	1210

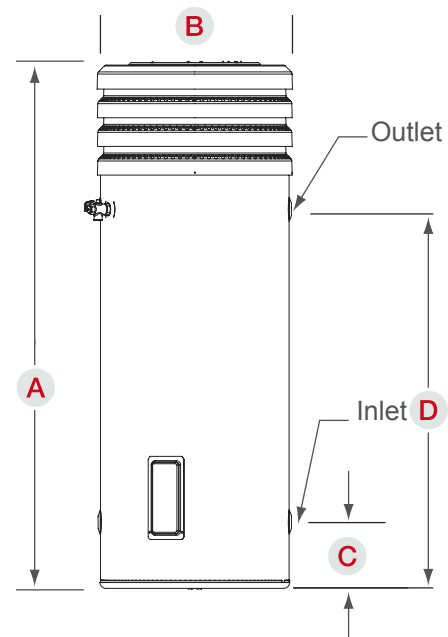

# ALWAYS HOT GAS CONTINUOUS FLOW

MODELS	CONDENSING MODELS		NON-CONDENSING MODELS		
Model Number - up to 50°C	21ECB5N / 21ECB5L	26ECB5N / 26ECB5L	17ENB5N / 17ENB5L	21ENB5N / 21ENB5L	26ENA5N / 26ENA5L
Model Number - up to 60°C	21ECB6N / 21ECB6L	26ECB6N / 26ECB6L	17ENB6N / 17ENB6L	21ENB6N / 21ENB6L	-
Model Number - up to 75°C	-	-	-	-	26ENA6N / 26ENA6L
Flow Rate (l/min @ 25° rise)	21	26	17	21	26
Min Operating Flow Rate (l/min)	2.4	2.4	2.4	2.4	2.4
Gas Consumption MJ/h - NG	145	175	125	159	200
Gas Consumption MJ/h - LPG	149	185	130	158	200
Star Rating	6.7	6.7	6.0	6.1	6.0
Gas Type	NG or LPG	NG or LPG	NG or LPG	NG or LPG	NG or LPG
Weight (kg)	17	18	14	15	22
Max water supply pressure (kPa)	1000	1000	1000	1000	1000
Min water supply pressure (kPa)	200	200	200	200	200
Cold Water Connection	20mm ¾"	20mm ¾"	20mm ¾"	20mm ¾"	20mm ¾"
Hot Water Connection (mm)	20mm ¾"	20mm ¾"	20mm ¾"	20mm ¾"	20mm ¾"
Gas Connection (mm)	20mm ¾"	20mm ¾"	20mm ¾"	20mm ¾"	20mm ¾"
Flue Diverter Part Number	CF-S37	CF-S37	CF-L39	CF-L38	CF-L18

DIMENSIONS (MM)	CONDENSING MODELS		NON-CONDENSING MODELS		
	21L/min	26L/min	17L/min	21L/min	26L/min
Model					
<b>A</b> Width	350	350	350	350	350
<b>B</b> Depth	170	170	170	170	170
<b>C</b> Height - Unit	520	520	520	520	600
<b>D</b> Height - Including Brackets	575	575	575	575	655
<b>E</b> Hot Water Outlet (From Back)	45	45	40	40	40
<b>F</b> Cold Water Inlet (From Back)	87	87	80	80	97
<b>G</b> Gas Connection (From Back)	40	40	40	40	40
Gas Connection Length (From Base)	50	50	50	50	49
<b>H</b> Cold Connection Length (From Base)	48	48	48	48	48
Hot Connection Length (From Base)	45	45	45	45	44
<b>I</b> Drain Outlet (From Back)	21	21	N/A	N/A	N/A
<b>J</b> Hot Water Outlet (From Centre)	138	138	131	131	131
<b>K</b> Drain & Cold Water Outlet (From Centre)	63	63	24	24	54
<b>L</b> Gas Connection (From Centre)	128	128	128	128	100

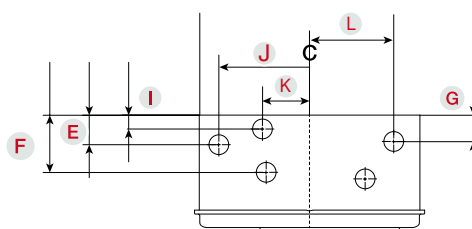
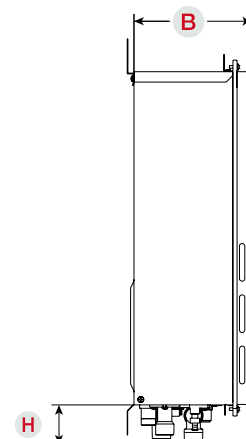
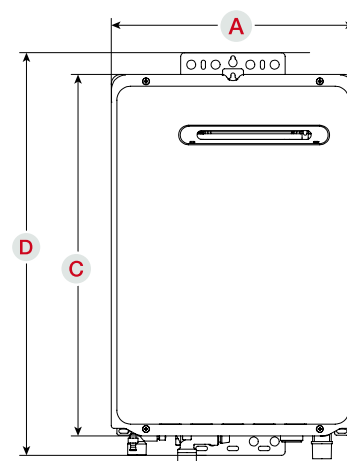

# SUNPRO® ELECTRIC BOOSTED SOLAR

	sunpro®		
TANK SPECIFICATIONS	2F136S	3F136S	4F136S
Storage Capacity (L)	259	321	415
Element Boost Capacity (L)	120	150	215
Net Tank Weight Empty (kg)	80	91	113
Relief Valve Pressure (kPa)	1000	1000	1000
Max Inlet Pressure (kPa)	800	800	800

TANK DIMENSIONS (MM)			
A Tank Height	1445	1765	1705
B Tank Diameter	620	620	705
C Tank Width	715	715	800
D Outlet	1210	1530	1445
E Inlet	195	195	220
F Solar Return	630	840	640

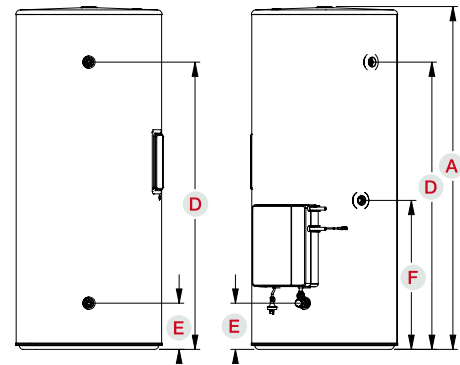
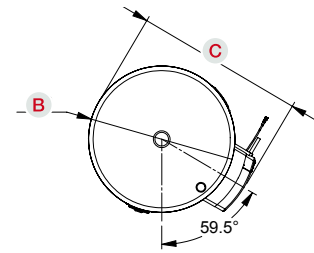

# SUNPRO® GAS BOOSTED SOLAR

	sunpro®	
TANK SPECIFICATIONS	DN15DT2DC / DL15DT2DC	
Nominal Capacity (L)	315	
Gas Consumption (MJ/Hr)	45	
Gas Type	Natural/Propane	
Net Weight Empty (Kg)	112	
Cold Water Socket Size (mm)	RP¾"/20	
Gas Pipe Inlet Size (mm)	RP½"/15	
Relief Valve Pressure (Kpa)	1000	

TANK DIMENSIONS (MM)	
A Tank Height	1765
B Tank Diameter	620
C Tank Depth	750

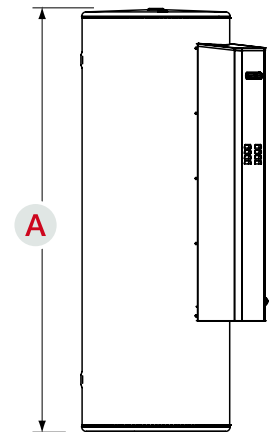
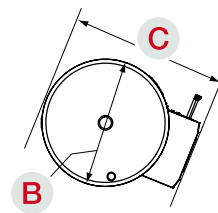

# SOLAR COLLECTORS

PANEL SPECIFICATIONS	2AP
Total Area (m²)	2
Weight Without Water (kg)	43
Glass Thickness (mm)	3.2
Glass Material	Toughened, Low Iron

PANEL DIMENSIONS (MM)	
Panel Height	2014
Panel Width	1080
Panel Depth	82





.....

**100**  
**YEARS**  
MANUFACTURING  
**IN AUSTRALIA**

1300 365 116

**dux.com.au**

## \*WARRANTY

Full warranty terms and conditions are in the product's Owners Manual,  
visit [www.dux.com.au/warranty-terms](http://www.dux.com.au/warranty-terms) for full details and conditions which apply.

Sales: 1300 365 116 Service: 1300 365 115 or visit [dux.com.au](http://dux.com.au) for more.

© 2018 Dux Manufacturing Limited ABN 19 077 879 844. Lackey Rd, PO Box 209 Moss Vale, NSW 2577.  
The information supplied was correct at time of printing. Specification and materials may change without notice.  
® and ™ Trademarks of Dux Manufacturing Limited. NOV 2018