





 FRL 60/60/60
per wall ONE WAY

 Rw 47-48
per wall

 R 2.1
per wall

 4.0 - 10 kN/m
per wall

Design Guide

HardieSmart™ ZeroLot™ Wall System
Class 1 & 10a Timber Frame Building

SYSTEMS

Australia May 2019

Make sure your information is up to date.

When specifying or installing James Hardie™ products, ensure that you have the current technical information and guides. If in doubt, or you need more information, visit www.jameshardie.com.au or Ask James Hardie™ on 13 11 03.



INDEX

- Introduction** 2
- System specification** 3
 - Dual zero lot 3
 - Single zero lot 3
 - System performance 3
 - Main components 3
 - HardieZeroLot™ panel accessories 4
 - Other components 4
 - Tools 4
- Overview and applications** 5
 - What is a “zero lot” line home? 5
 - Advantages 5
 - Minimum requirements 5
 - Applications 5
- Inspections and certification** 5
- Safe work practices** 6
 - Fibre cement 6
 - HardieFire™ insulation 6
- Design considerations** 7
 - General 7
 - Slab and footings 7
 - Termite management 7
 - Boundary setback 7
 - Fire resistance 7
 - Bracing performance 7
 - Thermal performance 7
 - Weather resistance 8
 - Coastal areas 8
 - Fastener type limitation 8
 - Component installation 8
 - Component substitution 8
 - Structure and framing 8
 - Services and fixtures 11
- Construction sequence** 12
- HardieZeroLot™ panel installation steps** 14
- System installation steps** 16
- Details** 20
 - Base details 20
 - Floor junctions 21
 - Roof details 22
 - Wall junctions 25
 - Wall services 26
- Online tools** 30
- Warranty** 30
- Codemark certification** 30

INTRODUCTION

This guide contains product information, technical specification, construction details and design considerations for the HardieSmart™ ZeroLot™ Wall System.

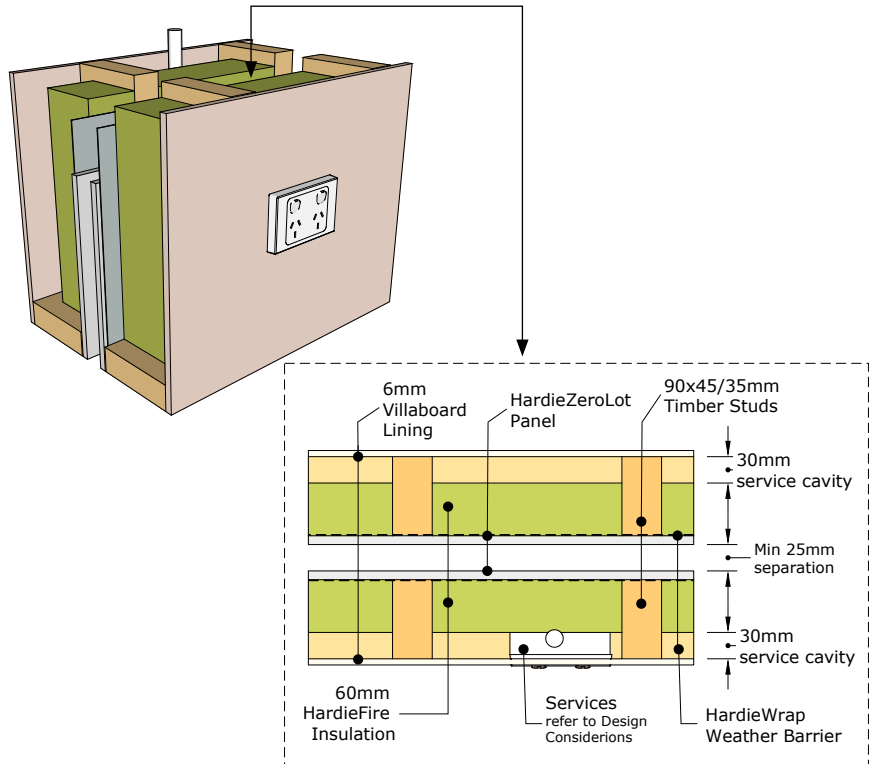

SYSTEM SPECIFICATION

DUAL ZERO LOT

For fully detached row housing.

90mm Timber Stud Frame

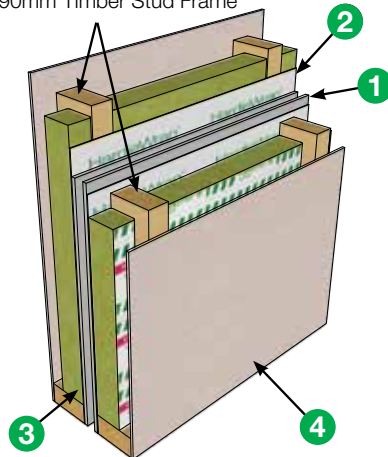

SINGLE ZERO LOT

For boundary walls built against existing walls

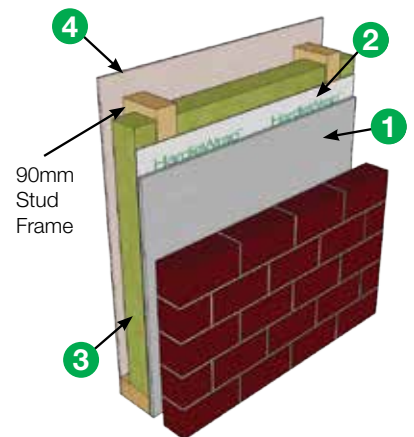

SYSTEM PERFORMANCE



FRL Per Wall
60/60/60 minutes ONE WAY



Total R-value Per Wall
2.1 m².K/W



Bracing Per Wall (depends on fixing method and selected cladding, refer to Design Considerations).
4.0 – 10 kN/m

Please refer to Design Considerations for framing specification, structural capacity, fire resistance and other limitations.

MAIN COMPONENTS

1

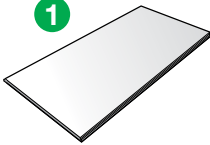

HARDIEZEROLOT™ PANEL

A fibre cement sheet with a ship lap joint along both 3000mm long edges. Pre-sealed with CoreShield™ technology and designed for unexposed maintenance-free applications.

Size (mm)	Part No	Mass (kg/m ²)
3000 x 1200 x 8.5	404880	12

2

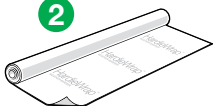

HARDIEWRAP™ WEATHER BARRIER

A non-perforated, highly breathable and reflective safe-glare weather barrier designed to be used behind cladding.

Size (mm)	Part No	Coverage (m ²)
2750 x 30,000	305664	82.5

Weight per roll (kg) 9

3

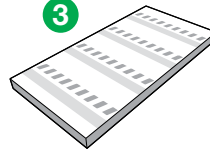

60MM HARDIEFIRE™ INSULATION

Mineral wool insulation specifically designed for use in fire applications with select HardieSmart™ Systems.

Pack Size 7

Size (mm)	Part No	Coverage (m ²)
560x1160x60	305903	5.1
420x1160x60	305902	3.8
420x1320x60	305909	4.3

Thickness (mm) 60

Material R-value (m² .K/W) 1.7

Density (kg/m³) 80

4

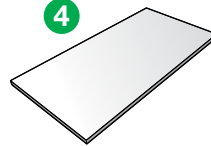

JAMES HARDIE™ INTERNAL LINING

Selected James Hardie™ internal lining must be at least 6mm thick. To see our range of suitable internal products, visit jameshardie.com.au or Ask James Hardie™ on 13 11 03.

6mm Villaboard™ lining is a fibre-cement sheet with a recessed edge. Suitable for tiled and untiled internal wall applications in dry and wet areas.

VILLABOARD 6MM

Sizes (mm)	Part No
900 x (2400, 3000)	See Villaboard™ lining manual
1200 x (1800, 2400, 2700, 3000, 3600, 4200)	
1350 x (2400, 3000, 3600, 4200)	

Mass (kg/m²) 8.3

HARDIEZEROLOT™ PANEL ACCESSORIES



JAMES HARDIE™ 9MM ALUMINIUM HORIZONTAL STEP FLASHING

A reversible aluminium flashing designed to be used at floor junctions and horizontal joints of HardieZeroLot™ panel.

Length (mm)	Part No	Pack Size
3600	305886	4 units per pack

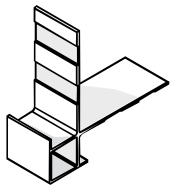

JAMES HARDIE™ ALUMINIUM 9MM EXTERNAL CORNER

A ready to paint aluminium extrusion to be used at external corner junctions to conceal the board edge.

Length (mm)	Part No	Pack Size
3000	305521	5 units per pack

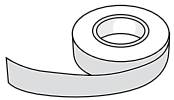

JAMES HARDIE™ 50MM WIDE FOAM BACK SEALING TAPE

A self-adhesive foam tape to help improve water tightness. It is applied under sheet joins to the HardieWrap™ weather barrier along the stud face.

Length (m)	Part No
25	304560

OTHER COMPONENTS



FASTENERS

(NOT SUPPLIED BY JAMES HARDIE)

Fibre Cement Nail

for fixing HardieZeroLot™ Panel and Villaboard™ lining.

2.8 x 30mm min.

Min. Class 3 corrosion resistant fibre cement nail.

2.5 x 50mm gun nails are also suitable. Check with nail manufacturer for suitability.

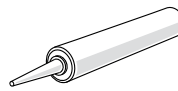

SEALANTS

(NOT SUPPLIED BY JAMES HARDIE)

Fire and Acoustic-Rated Sealant

Use Bostik FireBan One fire rated sealant or equivalent. If using an equivalent sealant it must be tested in accordance with AS 1530.4 and achieve a minimum 60 minute fire rating. Contact the relevant sealant manufacturer for more information.

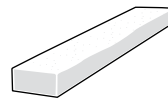

OTHER

(NOT SUPPLIED BY JAMES HARDIE)

Fire Resisting Mineral Wool

Used to seal cavities and maintain FRL at junctions of the selected wall system. Please see Construction Details for applications. Refer to manufacturer for guidance on installation.

TOOLS

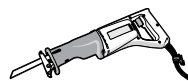

Reciprocating Saw, Utility Knife or Hand Saw for Cutting HardieFire™ Insulation

Used for cutting insulation when required. Ensure to cut 5mm wider than required to ensure compression of insulation in the cavity.

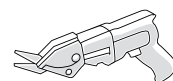

Tools For Fibre Cement

A suite of tools are available for cutting and handling James Hardie™ fibre cement. Please refer to James Hardie's Best Practice Guide for more information.

OVERVIEW AND APPLICATIONS

WHAT IS A “ZERO LOT” LINE HOME?

When a building has one external wall built against the property line the house is said to have a virtually “zero lot” line. This is common in terrace style homes.

HardieSmart™ Dual ZeroLot™ Wall System comprises of two HardieSmart™ Boundary Walls built back to back with at least one built modularly.

The external wall face is fitted with a specialised pre-sealed cladding known as HardieZeroLot™ Panel designed for areas with restricted access for maintenance.

ADVANTAGES

- Creates more usable space within the lot,
- Maximises indoor space using a compact solution,
- Flexible building process: the construction of independent structures, rather than traditional semi-detached buildings,
- Connection to adjoining properties is not required as the system is built and placed in modules.

MINIMUM REQUIREMENTS

The HardieSmart™ ZeroLot™ Wall System is designed for dual and single zero lot boundaries. It is suitable for use in Class 1 and 10a timber-framed buildings with a Fire Resistance Level (FRL) requirement of 60/60/60 minutes or less. For higher FRL, please consult James Hardie.

APPLICATIONS

Typical applications are depicted below. These are based on National Construction Code (NCC) Volume 2 and do not cover all applications and limitations, the designer must check all NCC requirements before specifying. If more information is required to assess suitability, please contact James Hardie.

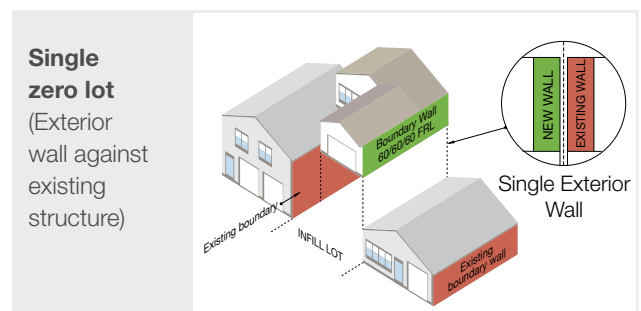
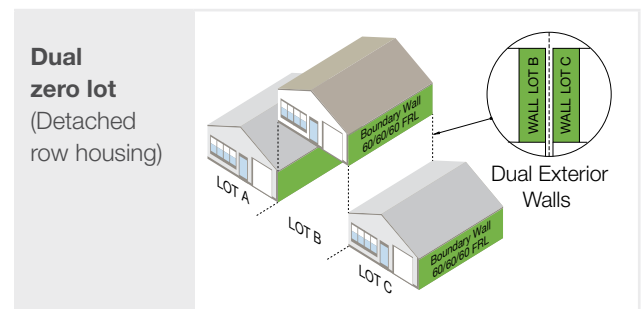

INSPECTIONS AND CERTIFICATION

The HardieSmart™ wall system may require inspection and certification by a third party to ensure the construction conforms to the relevant requirements of the NCC and local regulations. The inspections will typically be carried out by a certifier or surveyor. To assist in ensuring the wall system has been correctly built, James Hardie recommend

completing the Site Installation Checklist at the end of this guide. We can also provide any relevant documentation, such as the relevant CodeMark certificate and test reports, to certifiers and surveyors upon request via our Engineering Solutions team on 13 11 03.

SAFE WORK PRACTICES

FIBRE CEMENT

James Hardie™ products contain sand, a source of respirable crystalline silica which is considered by some international authorities to be a cause of cancer from some occupational sources. Breathing excessive amounts of respirable silica dust can also cause a disabling and potentially fatal lung disease called silicosis, and has been linked with other diseases.

During installation or handling, ensure to follow James Hardie's Best Practice Book and SDS for James Hardie™ fibre cement products available at jameshardie.com.au.

HARDIEFIRE™ INSULATION

ELECTRICAL CONDUCTIVITY

Foil facings are conductive to electricity. Care must be taken when installing HardieFire™ insulation in the proximity of electrical wiring and lighting fixtures. Avoid contact with uninsulated electrical cables and fittings. If required, HardieFire™ foil facing may be removed using a utility knife. Consult a qualified Electrician, or contact James Hardie for further information.

STORAGE AND HANDLING

Store in an internal dry area, out of direct sunlight and not exposed to chemicals. It must not be installed during an electrical storm and it must be installed in a dry state to a dry surface and protected from weather during transport and storage. HardieFire™ insulation has not been designed to withstand prolonged direct exposure to the exterior elements. Ensure that the insulation is completely dry prior to fitting.

PROTECTIVE EQUIPMENT

Keep exposure to a minimum and minimise quantities kept in work areas. Avoid contact with eyes. When handling and installing HardieFire™ insulation, to prevent irritation ensure you wear:

- Safety goggles/glasses conforming to AS/NZS 1336,
- Protective clothing such as gloves and long sleeve shirts and trousers,
- P1 or P2 respirators.

BEFORE INSTALLATION

- You must turn the mains power 'Off' before entering the workspace. If in doubt, you must consult a licensed electrician.
- Care and safety measures must be followed when working in areas that contain live electrical wiring.
- Defective electrical cables, terminals or any other electrical wiring must be repaired by the relevant specialist prior to installation.
- Ensure workspace has adequate and ample ventilation. If working in confined spaces, it is recommended to use a HEPA vacuum or other suitable dust extractors.
- Before entering workspace, complete a risk assessment inspection to identify and manage hazards including but not limited to electrical, site access and ventilation.

CUTTING

It is recommended to cut outdoors. If cutting indoors, please ensure that workspace is properly ventilated or HEPA vacuums/dust extractors are used.

1. Position cutting station so wind will blow dust away from the user or others in working area.
2. Use either a hand saw or a reciprocating saw.

DISPOSAL

Discard any waste pieces of HardieFire™ insulation in accordance with your local council guidelines. Dispose of the material in such a manner to prevent exposure and escape.

FURTHER HEALTH AND SAFETY INFORMATION

For more information refer to the HardieFire™ insulation SDS available at jameshardie.com.au.

DESIGN CONSIDERATIONS

GENERAL

All design and construction must comply with the appropriate requirements of the NCC and other applicable regulations and standards. The specifier or other party responsible for the project must ensure that the details in this specification are appropriate for the intended application and that additional detailing is performed for specific design or any areas that fall outside the scope of this specification.

SLAB AND FOOTINGS

The slab and footings on which the building is situated must comply with AS 2870 'Residential Slabs and Footings – Construction' and the requirements of the NCC.

SLAB SEPARATION: For detached construction, the designer must ensure that there is suitable slab separation between dwellings. This can be achieved by using a flexible bond breaking material (e.g. material for control joints) when setting out the slab (See Figure 8). Refer to NCC and local regulations for more information.

TERMITE MANAGEMENT

Due to restricted access at zero lot boundary walls, a suitable and certified termite management mechanism in accordance with AS 3660.1 or a reticulation system must be installed at the boundary slab e.g. Termimesh, Cordon and alike. Please consult the relevant manufacturer for more information.

BOUNDARY SETBACK

The HardieSmart™ ZeroLot™ Wall System specifies a minimum setback of 12.5mm from the boundary line when capped and installed in accordance with this guide.

When the HardieSmart™ ZeroLot™ Wall System is not capped and is built against an existing structure, a minimum setback of 500mm is recommended. Due to exposure, the HardieSmart™ ZeroLot™ panels will need to be coated and maintained in accordance with this guide (see coating section).

Please note that council, state or other regulations may apply in your development which specify different setbacks, height, width and other design criteria. Additionally, confirmation in writing in the form of a statutory declaration from the registered owner of the adjoining premises may be required to demonstrate compliance. The designer or specifier must ensure that the system is fit for purpose and complies with the relevant requirements and regulations.

FIRE RESISTANCE

NCC Vol. 2 Part 3.7.2 requires boundary walls to maintain an FRL of 60/60/60 minutes. HardieSmart™ Systems have been assessed by the CSIRO Division of Building Construction and Engineering and the Building Research Association of New Zealand (BRANZ) in accordance with the principles of AS1530.4 FCO-3222 Rev H).

BRACING PERFORMANCE

For two sided systems i.e. comprising of both James Hardie™ external cladding and internal lining products of ≥6mm in thickness, the bracing capacity is typically 4 kN/m for plain timber framing and standard fixing methods. The capacity may be increased to a range of 6-10 kN/m for other fixing methods and anchor rods of 12mm diameter. For more information and specification, the designer must refer to James Hardie's Structural Bracing Application Guide (designed in accordance with AS 1684 'Residential Timber Framed Construction'). James Hardie's Structural Bracing Application Guide contains fixing details and bracing capacity for James Hardie™ sheet bracing and other fibre cement cladding. All design capacities quoted are Ultimate Limit State (ULS) figures and have been certified by consulting engineers, Cardno (NSW). Pty Ltd.

THERMAL PERFORMANCE

This guide outlines certified modelled Total R-values for HardieSmart™ Wall Systems. Use this information to assist in satisfying the minimum deemed to satisfy NCC thermal resistance requirements and in verification software tools.

The Total R-values for common systems are in accordance with AS4859.1:2002 including Amendment 1:2006 'Materials for Thermal Insulation of Buildings'.

WEATHER RESISTANCE

The external cladding of the HardieSmart™ ZeroLot™ wall system has been designed in accordance with Clause P2.2.2 of the NCC. For any variations, it is the responsibility of the designer or specifier to identify moisture related risks associated with any particular building design. Wall construction design must effectively manage moisture, accounting for both the interior and exterior environments of the building, particularly in buildings that have a higher risk of wind-driven rain penetration or that are artificially heated or cooled. All wall openings, penetrations, intersections, connections, window sills, heads and jambs must be flashed prior to cladding installation.

COASTAL AREAS

In areas within 1km of a coastal area, areas subject to salt spray and other corrosive environments, Class 4 fasteners must be used. All other areas require a minimum Class 3 fastener. Fasteners must be fully compatible with all other materials that they are in contact with to ensure the durability and integrity of the assembly. Contact the fastener manufacturer for more information.

FASTENER TYPE LIMITATION

Brad nail and/or adhesive fixings are not recommended in fire and acoustic-rated systems. Please refer to the respective lining or cladding for alternative fixing methods.

COMPONENT INSTALLATION

HARDIEWRAP™ WEATHER BARRIER

Refer to the HardieWrap™ weather barrier datasheet for more information on standard installation.

For modular construction, follow this guide.

60mm HARDIEFIRE™ INSULATION

Must be used as the frame cavity infill and must be compressed 5mm minimum in both vertical and horizontal directions (i.e. batt size must be at a minimum 5mm wider and longer than frame stud bay). Avoid joints in insulation batts, if present, all gaps must be filled with compressed HardieFire™ insulation. Position batts hard against external wall face to allow for an internal service cavity. Foil size should face the internal lining.

JAMES HARDIE™ INTERNAL LINING

Villaboard™ lining must be installed in accordance with the current Villaboard™ lining installation instructions. Alternative James Hardie™ internal linings with a minimum of 6mm thick may be used when installed in accordance with the relevant manual.

HARDIEZEROLOT™ PANEL

Follow this guide.

OTHERS

For other components not supplied by James Hardie ensure to follow the instructions set out in this guide and the respective manufacturer's recommendations.

COMPONENT SUBSTITUTION

James Hardie™ fibre cement products and components such as HardieFire™ insulation and HardieWrap™ weather barrier must be as specified in the system.

No statement of performance will be provided by James Hardie when alternative products are used.

STRUCTURE AND FRAMING

NCC Section 3.4.3 requires timber framing to be designed and constructed in accordance with AS1684 suite which defines the minimum requirements for compliance including, but not limited to maximum of three storeys, spans, cantilevers, maximum wall heights, timber grades, timber cross-sections, lateral restraint, bracing, racking and axial capacity. The specifier or other party must ensure that any details outside the scope of the AS1684 suite is engineered to comply with the relevant structural performance provisions of the NCC.

In addition to the above, the following table and details in this guide provide further structural constraints and conditions to maintain the fire resistance level (FRL) of the wall system. For any applications outside the scope of the tables below, contact the Engineering Solutions team on 13 11 03.

MATERIAL

Seasoned timber only. Timber used for house construction must have the level of durability appropriate for the relevant climate and expected service life. Must use minimum MGP10 grade timber in accordance with AS1748, or LVL with equivalent strength, stiffness and density properties, manufactured in accordance with AS/NZS 4357.0. Reference AS1684 'Residential Timber Framed Construction'.

STRUCTURAL CAPACITY

The load bearing capacities of the timber-framed walls must be in accordance with AS1684 and AS1720. Note that studs and joists should be aligned with minimum offset, or the load diverted by structural blocking or other method, in accordance with relevant timber codes and standards.

TABLE 1

LOADBEARING WALLS			DRILLED STUDS - 25MM @ 10MM	
Max Stud Height* (mm)	Min Stud Size (mm)	Stud Load Capacity (kN/stud)	Maximum Wind Load	
			600mm centres	450mm centres
2700	90x35	3.1	N3	N3/C1
	90x45	4.3	N4/C1	N4/C1
3000	90x35	3.1	N2	N3
	90x45	4.3	N2	N3
3300	90x35	2.9	-	-
	90x45	3.7	N1	N2
3600	90x45	2.9	-	N1
3900	90x70 (2@90x35)	3.5	N1	N2
4200	90x90 (2@90x45)	3.6	N2	N2

* In accordance with Figure 1 Framing Configuration diagram.
 ~ Only applies to studs which are drilled horizontally to pass services. Refer to Figure 1 Framing Configuration diagram. Note that ZeroLot walls will typically not exceed N2 Wind Classification in accordance with AS4055 due to limited wind exposure.

TABLE 2

NON-LOADBEARING WALLS	
Max Stud Height (mm)	Min Stud Size (mm)
3600	90x35
4200	90x45
4500	90x90 (2@90x45)

NOTE: When walls are to be drilled to pass services refer to Wind Load limits in Table 1 Loadbearing Walls and Framing Configuration diagram.

STUD SPACING

600mm maximum. Check whether you require closer stud spacings for your site wind pressures and tile weight (where applicable). ^See Structural Capacity above.

HardieFire™ insulation sizes have been optimised for 45mm studs at 600mm centres and 35mm studs at 450mm centres, cutting may be required otherwise.

NOGGING FOR LOAD BEARING WALLS

Minimum 90mm deep. Installed flat in accordance with Figure 1 Framing Configuration Diagram

Maximum 1200mm spacing

NOTE: It is recommended noggings installed in line instead of staggered to facilitate insulation installation.

CANTILEVERED FLOORS

Cantilevered floors maximum span need to be designed in accordance with 'AS1684.2 Residential timber-framed construction'. Please refer to your Structural Engineer or qualified person for further design analysis.

STUD DRILLING

Where the stud is to be penetrated horizontally to allow services to pass between stud bays, only 1 in every 5 studs may be drilled a maximum of 25mm in diameter, 10mm from the edge. Any larger or additional penetrations must *not* be located within the middle third of the stud height as per the Framing Configuration diagram below, and may require reduced stud spacing, or thicker studs in accordance with Table 1. Refer to Figure 1 Diagram D.

TOLERANCE

Ensure frame is square and work from a central datum line. Frames must be straight and true to provide a flush face to receive the sheeting. A suggested maximum tolerance of between 3mm and 4mm in any 3000mm length will give best results.

SACRIFICIAL TIMBER

Sacrificial timber blocking (also known as char blocking) is used in addition to the standard timber framing to protect structural members from fire. Sacrificial timber is differentiated by red hatching in the Construction Details section of this guide.

Sacrificial timber should have a minimum density of 550kg/m³, and be pine or LVL of minimum 45mm thickness. Blocks are to be arranged so that they are continuous or, additional blocking installed in front of any joints.

Ensure framing manufacturer accounts for additional sacrificial timber blocking at wall, floor and roof junction as per Figure 1.

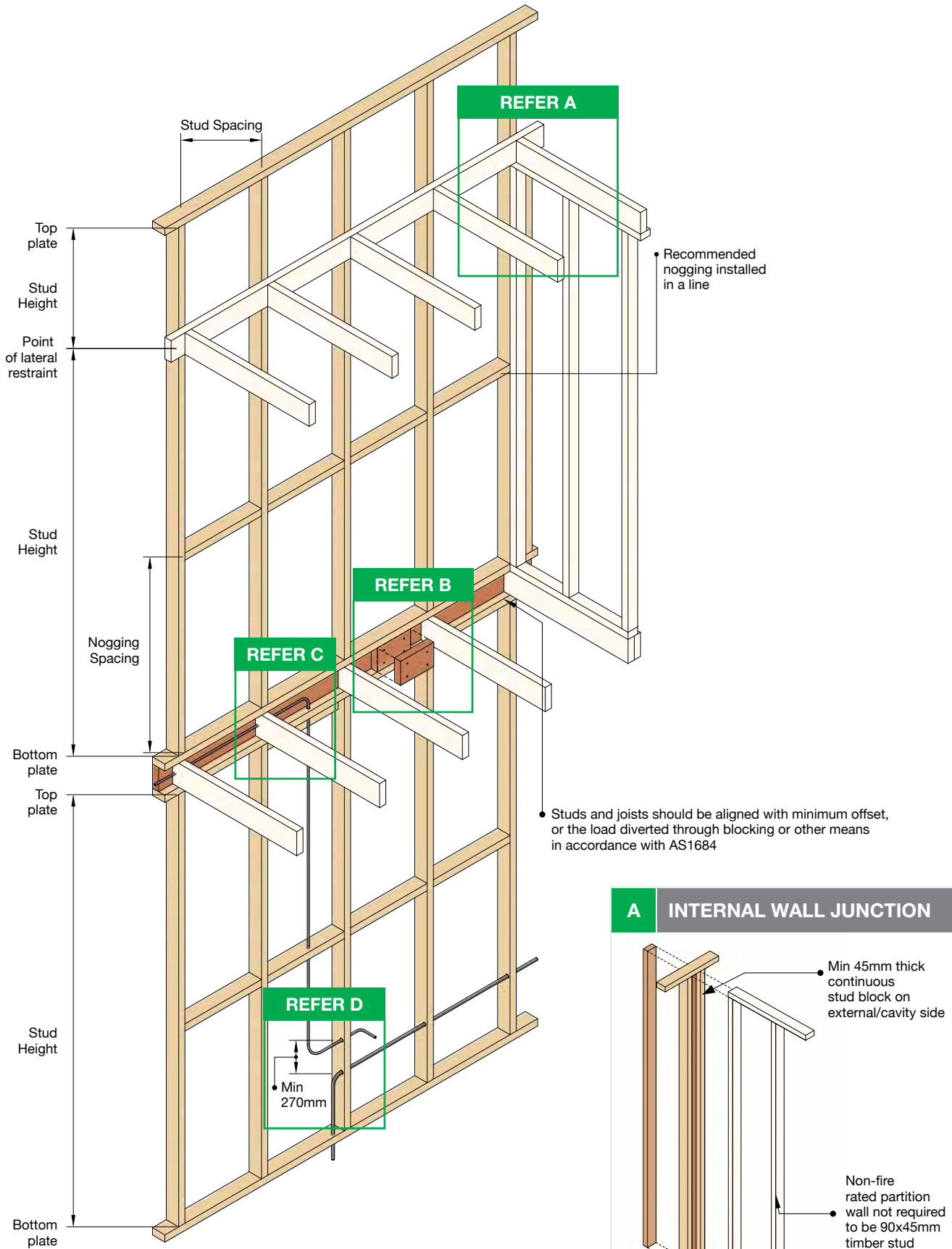

HARDIESMART™ FRAMING CONFIGURATION DIAGRAM

FIGURE 1

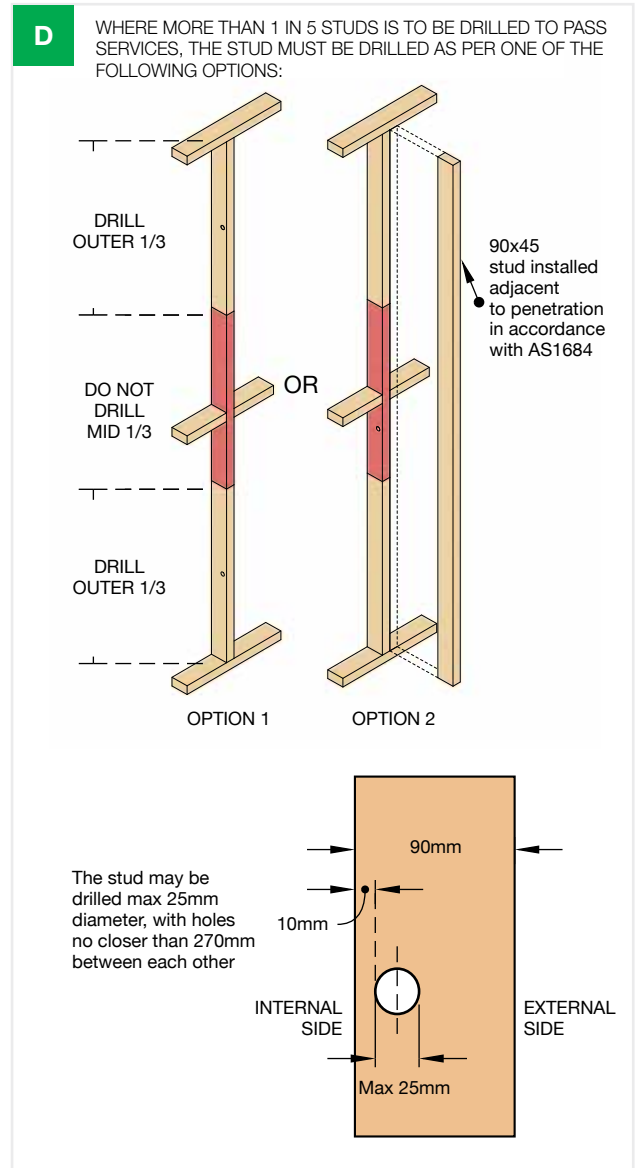
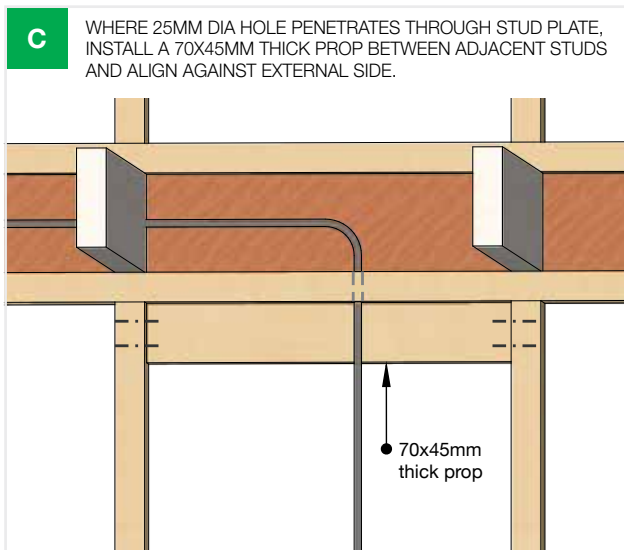
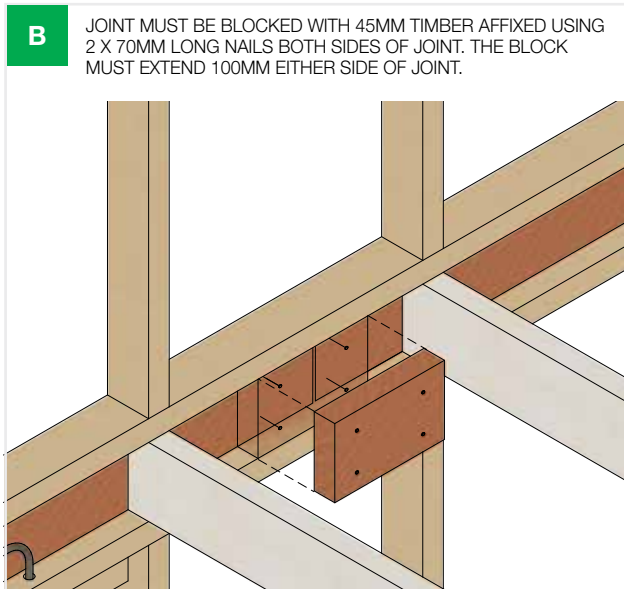

SERVICES AND FIXTURES

The service cavity is designed to allow services to be run vertically from the ceiling into the wall. Where services run horizontally through the studs to pass between bays, refer to the 'Framing' section under Design Considerations and Figures 36-41 for installation guidelines.

Services may only be run in the service cavity between the insulation and the lining (i.e. must not exceed 20mm deep).

WARNING: When fixing lining, avoid nailing near pipes or cables as it may cause damage.

ELECTRICAL CABLES

Electrical cables may be run within the service cavity. Refer to Figures 36 to 38.

PLUMBING AND ELECTRICAL CONDUITS

Pipes with a diameter up to 20mm may be run in the service cavity as per Figure 35. Any larger pipes must be relocated to non-fire rated partitions. For taps and other details, refer to Figures 39-41.

AIR-CONDITIONING

Pipes with an outside diameter up to 20mm and carrying non-flammable refrigerants may be run inside the service cavity.

WALL FIXTURES

When fixing brackets, cabinets, shelves or any other fixture that requires the wall to carry a load, they must be fixed to the framing member (i.e. studs) and must not rely solely on the lining.

CONSTRUCTION SEQUENCE

When constructing a dual zero lot system, one external wall may be built with the standard construction method. The adjacent wall will need to be built in modules. Wall modules can be built in-situ or prefabricated by a specialised frame manufacturer for on-site assembly.

1 SLAB SEPARATION

Provide slab separation between tenancies and install termite barrier. See Design Considerations.

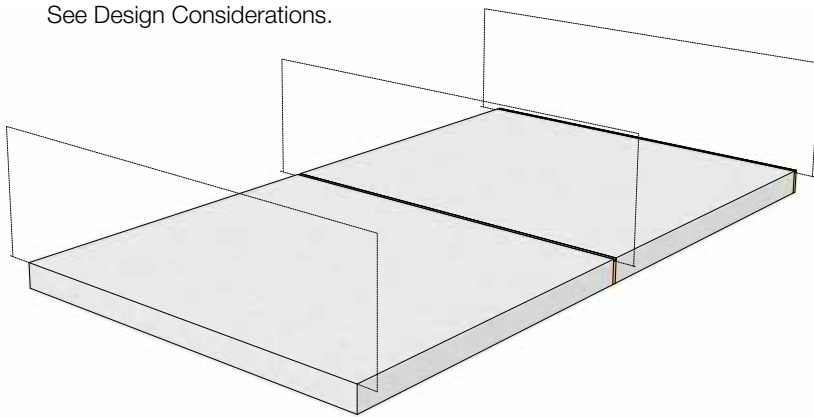

2 FIRST WALL CONSTRUCTION

Build, tilt, fix and brace wall modules.

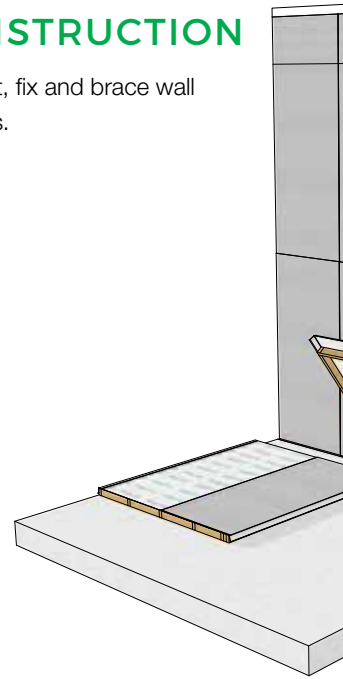

4 UPPER STOREY MODULAR WALL

Repeat steps of lower storey; however, note that James Hardie™ Step Flashing is required at the floor junction.

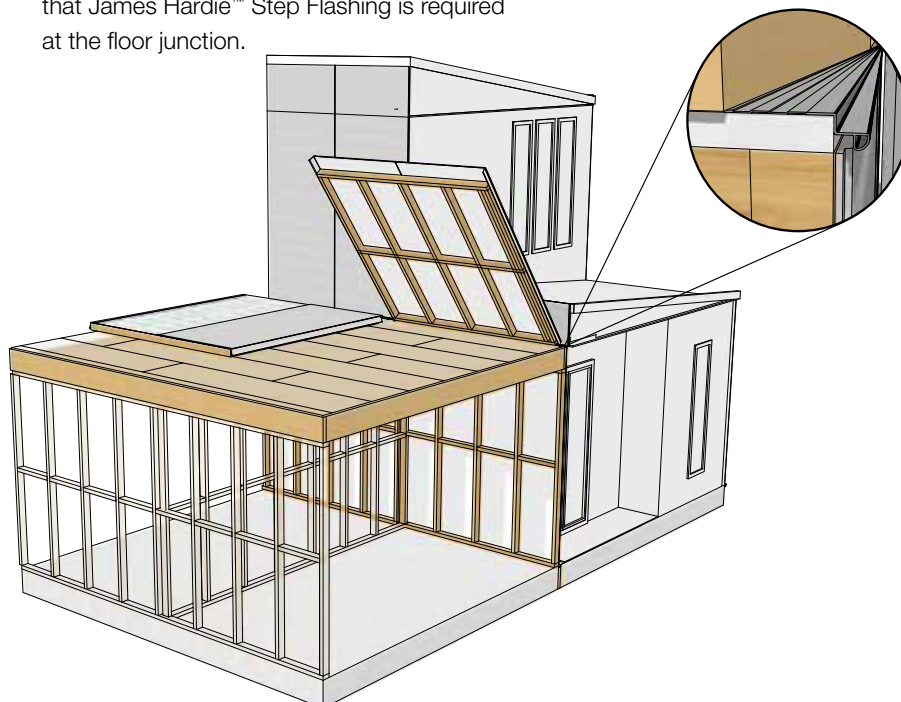

5 ROOF TREATMENT

Install HardieFire™ insulation and lining up to the roof line before installing roof trusses. See installation steps for modular construction.

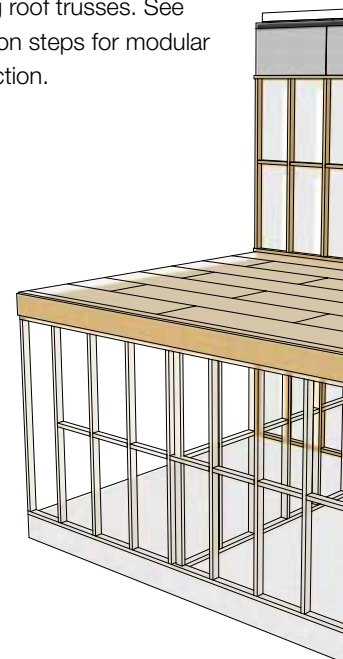

3 BUILDING FIRST FLOOR

Several options are available for joist treatment, refer to Construction Details and modular installation steps.

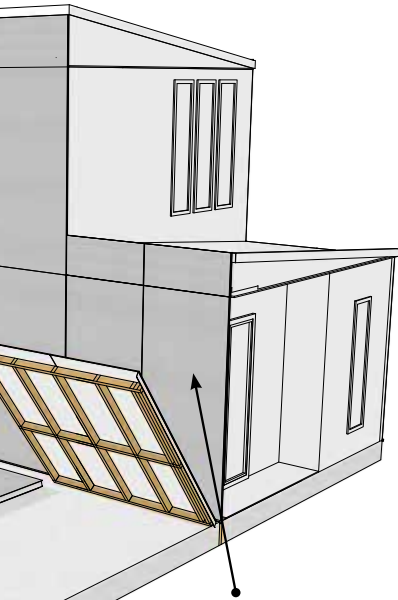

Existing or newly built wall in standard construction method (see p.10-11)

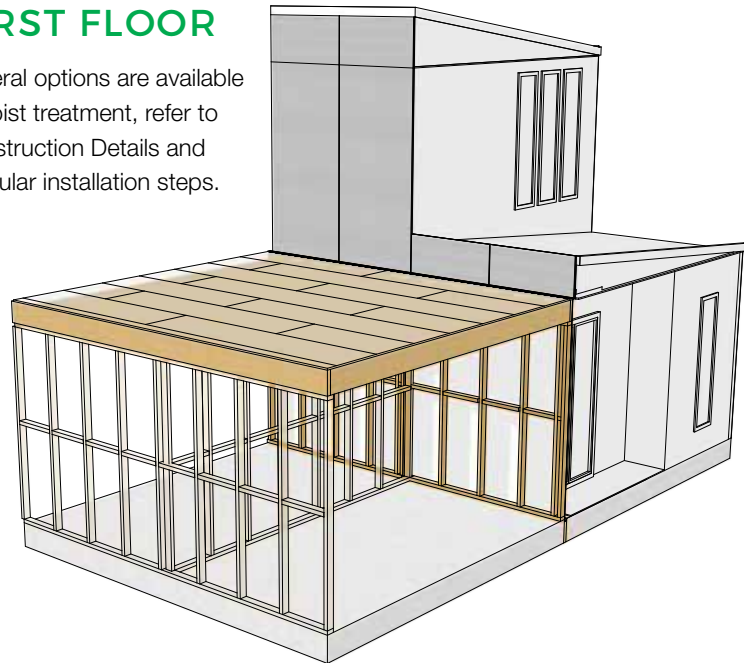

6 INSULATION, LINING AND SERVICES.

Install HardieFire™ insulation, services and lining. Services are run vertically from the top or bottom plates, see Figure 36-41 for pipe installation instructions.

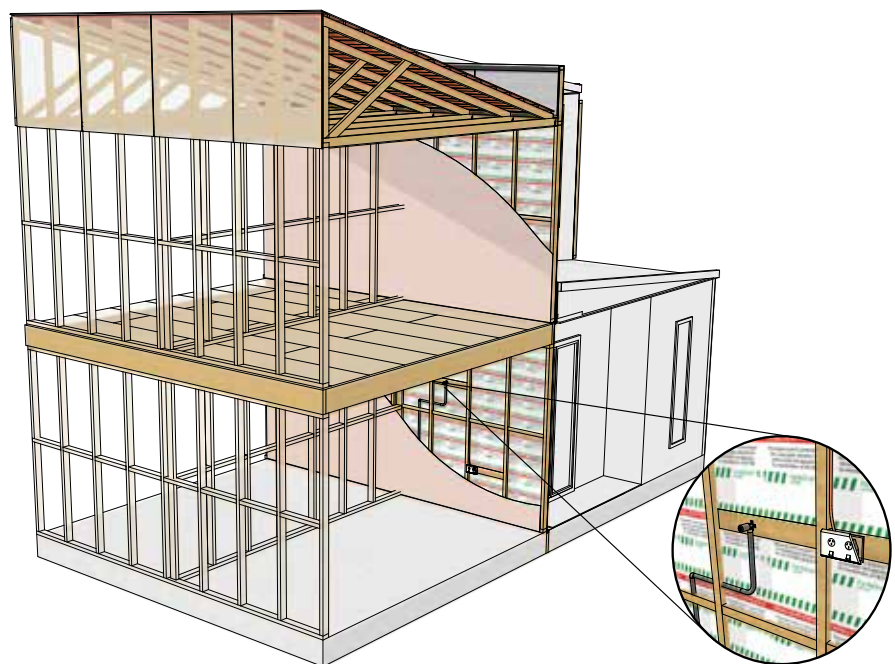
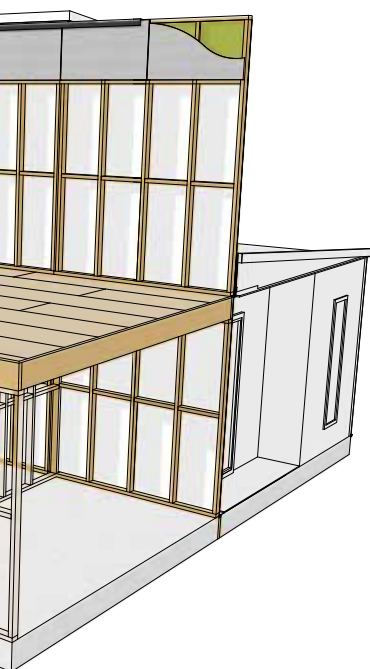

HARDIEZEROLOT™ PANEL INSTALLATION STEPS

UNRESTRICTED SITE ACCESS

STEP 1 FRAME PREPARATION

Construct frame to suit the site wind classification in accordance with the Structure and Framing section (Tables 1 and 2). Note that corners and junctions will require additional stud members. Refer to the relevant Construction Details.

STEP 2 FRAMING, WRAP AND FLASHINGS

Ensure that frame is straight. James Hardie recommends a maximum tolerance of 3mm in 3000mm. Affix HardieWrap™ weather barrier to frame followed by corner accessories.

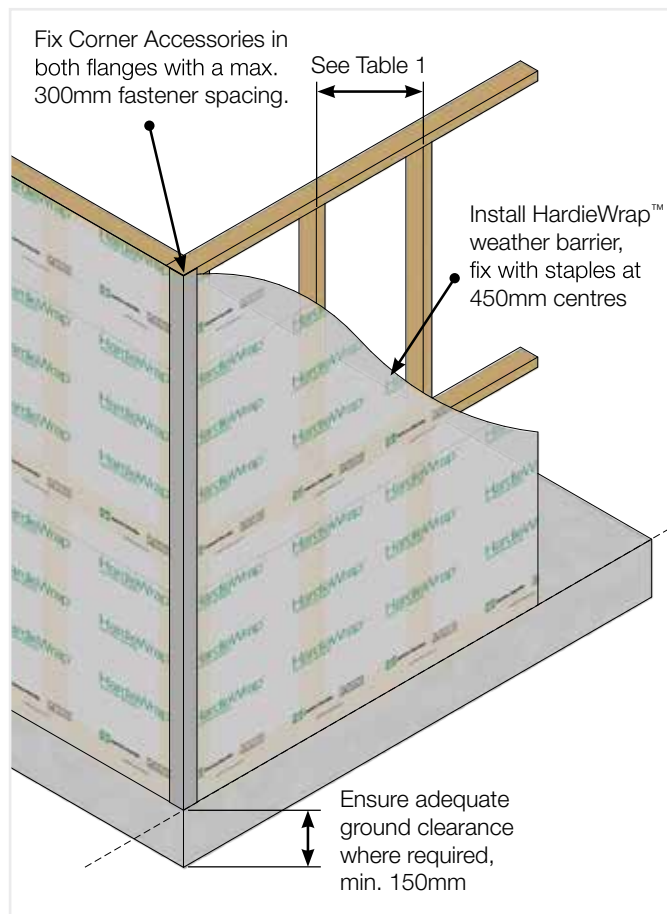

FIGURE 2 FRAME PREPARATION

STEP 3 FOAM TAPE

At every vertical sheet joint, a 50mm foam back sealing tape is applied under the shiplap vertical joint and in front of the HardieWrap™ weather barrier.

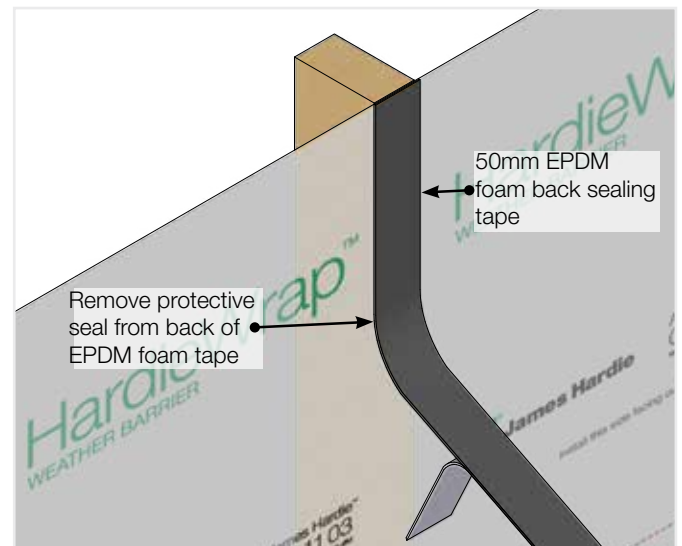

FIGURE 3 FOAM TAPE APPLICATION

STEP 4 POSITION

HardieZeroLot™ panel must be installed vertically with all sheet edges fully supported. Centre of sheet joints must coincide with the centre line of the framing member and all sheets are installed in one direction. To ensure the fasteners fixed at the edge of the sheet have sufficient clearance from the edge, position the underlap sheet 3mm beyond the centre of the stud at every stud.

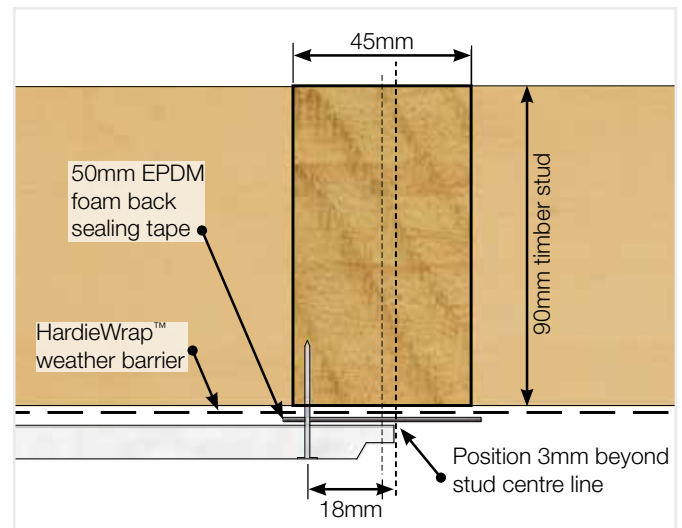

FIGURE 4 FIRST PANEL PLACEMENT

STEP 5 FIX FIRST PANEL

Fix the first HardieZeroLot™ panel with the recommended nails as per Figure 4. **Nails must be driven flush, do not overdrive.**

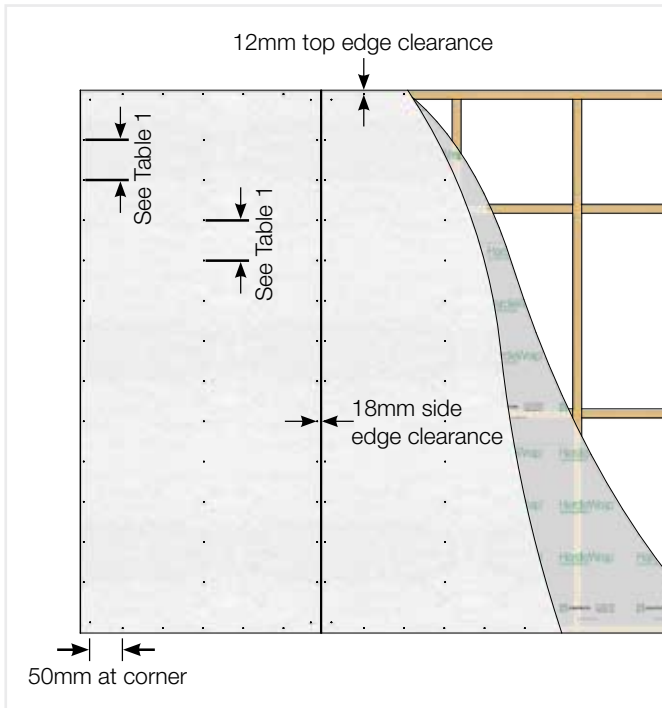

FIGURE 5 FASTENER SPACING

STEP 6 APPLY JOINT SEALANT

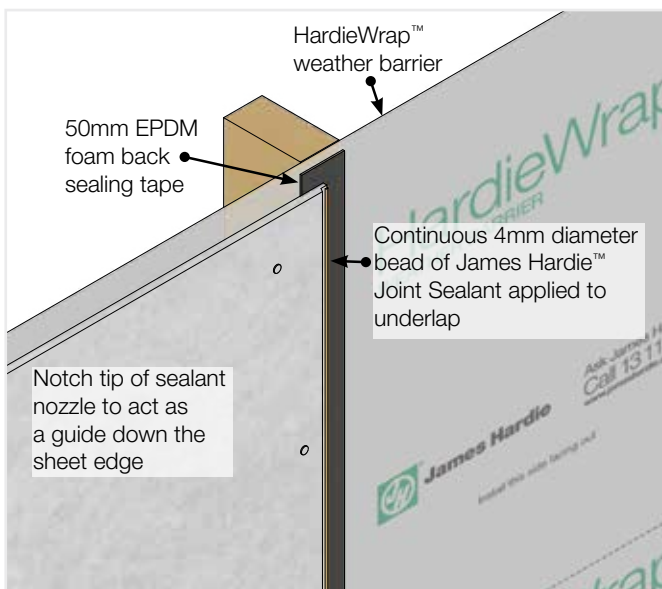

FIGURE 6 APPLY JOINT SEALANT TO SHIPLAP JOINT

STEP 7 FIX SUBSEQUENT PANELS

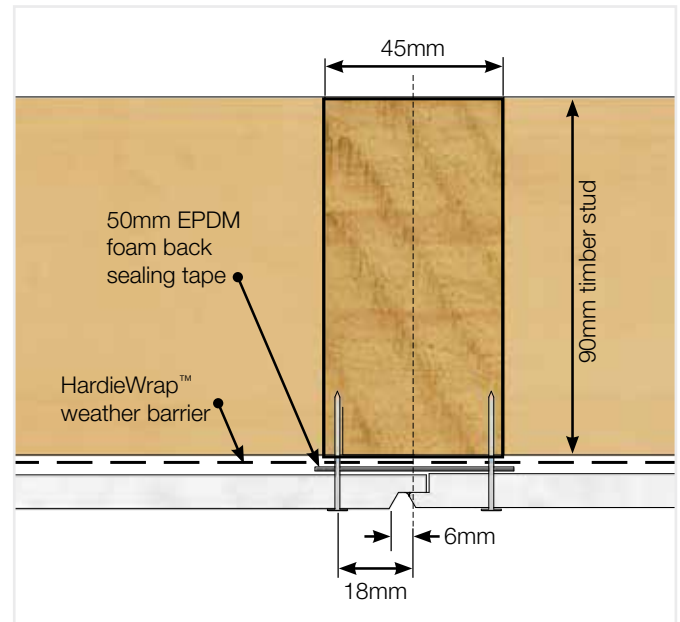

FIGURE 7 SECOND PANEL FASTENER CLEARANCE

STEP 8 COATING (ONLY FOR EXPOSED AREAS)

HardieZeroLot™ panels are factory sealed with James Hardie's CoreShield™ technology penetrating sealer. This sealer has been designed for zero lot applications and does not require additional coating; however, for wall areas that are visible and fully exposed to the elements, you must apply a roll-on texture coat within 6 months of fixing.

All sheets must be dry before painting. James Hardie recommends the application of a roll-on exterior texture coat system over the panels in accordance with the paint manufacturer's specifications. Some environments require special coatings including coastal areas. Painting specifications are dependant on the paint chosen. Refer to the paint manufacturer for further information, product suitability, specifications, maintenance and details of their warranty.

SYSTEM INSTALLATION STEPS

RESTRICTED SITE ACCESS

STEP 1 STAGE MATERIALS

The components required for the HardieSmart™ ZeroLot™ Wall System must be staged during construction. Typically, a set of materials are required at framing stage and others at lining stage. The below lists do not consider all elements required for construction such as nails, adhesives, etc. Refer to the Accessories section for more information.

FRAMING STAGE: Involves building wall modules. These comprise of the following components:

- Timber frame
- HardieWrap™ weather barrier
- HardieZeroLot™ panels
- James Hardie™ Step Flashing
- James Hardie™ 50mm wide Foam Back Sealing Tape

NOTE: A small portion of HardieFire™ insulation may be required at framing stage for roof cavity, see installation sequence.

LINING STAGE:

- HardieFire™ insulation
- Villaboard™ lining
- Fire and acoustic-rated joint sealant

STEP 2 SET OUT SLAB OR BASE

Install slab separation and termite management system in accordance with the Design Considerations section.

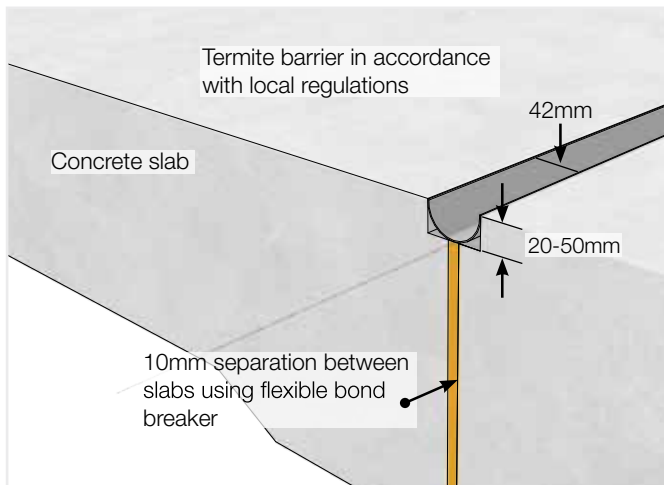

FIGURE 8 SLAB SEPARATION

STEP 3 DETERMINE WALL MODULE SIZE

Ensure you have selected the optimum lengths and heights of wall modules. This is critical to achieve optimum speed of construction and ease of installation. Wall modules height and length should not exceed 3.6m. To determine wall module dimensions, you must consider the following:

- HardieZeroLot™ panel sizes;
- Boundary wall length and height (wall module must not exceed storey height);
- Module weight, please refer to Table 3.

When planning your wall module lengths, ensure cut edges are placed in the wall ends and intermediate modules are a multiple of the sheet width in length as the shiplap factory edge (Figure 8) is required for module jointing, refer to Figure 15.

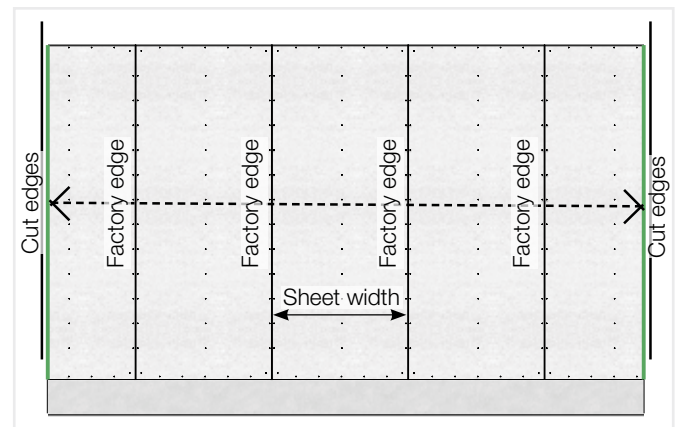

FIGURE 9 WALL MODULE SIZE AND EDGES

Module Weight (kg)	Module Width (mm)				
	1200	2400	3600	4800	
Module Height (mm)	2400	41.5	81.3	121.0	160.8
	2700	46.0	90.3	134.6	178.9
	3000	50.6	99.4	148.2	197.1
	3200	53.6	105.5	157.3	209.2

TABLE 3 WALL MODULES WEIGHT FOR 600MM STUD CENTRE

Table Notes: Please note that masses and dimensions are approximate only. These are subjected to manufacturing tolerances and other factors such as moisture content. The weights listed below have been used in the values set out in Table 3. It does not consider flashings, damp-proof course and any other elements not listed below:

- Timber frame: 429 kg/m³. Assuming density of softwood traditional pine timber studs with a moisture content of 16.2%, which may vary.
- HardieWrap™ weather barrier: 0.11kg/m²
- HardieZeroLot™ panels: 12 kg/m²

STEP 4 BUILD WALL FRAMES

Build the frame modules on ground in accordance with the Structure and Framing section. Add the required additional timber blocking at wall intersections.

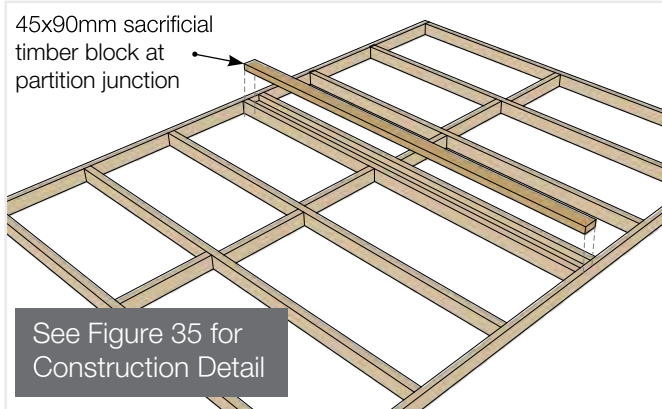

FIGURE 10 SACRIFICIAL TIMBER AT WALL JUNCTIONS

STEP 5 LEVEL & BRACE

Once pre-built, place the frame into position to check levelling.

Ensure frame module is levelled and square (e.g. cross-braced).

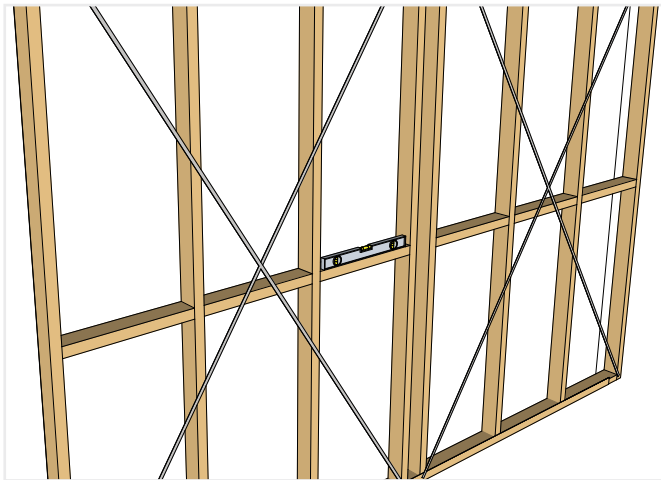

FIGURE 11 LEVELLING WALL FRAMES

STEP 6 HARDIEWRAP™ WEATHER BARRIER AND FOAM TAPE

After frames are levelled and braced, place back on the ground and install HardieWrap™ weather barrier. It is recommended to fix with a suitable hammer tacker and staples at 450mm centres. Overhang the wrap by min. 150mm from frame side edges. This is required when jointing wall modules, see Figure 16.

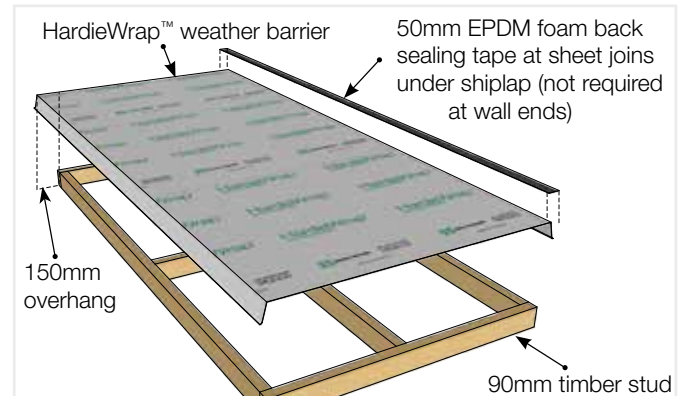

FIGURE 12 HARDIEWRAP™ INSTALLATION

STEP 7 HARDIEZEROLOT™ PANELS

On each module:

1. Ensure that on one end, the overlap of the HardieZeroLot™ panel is hanging off the frame by 25mm.
2. On the other end, the underlap should be 20mm inside the frame edge.

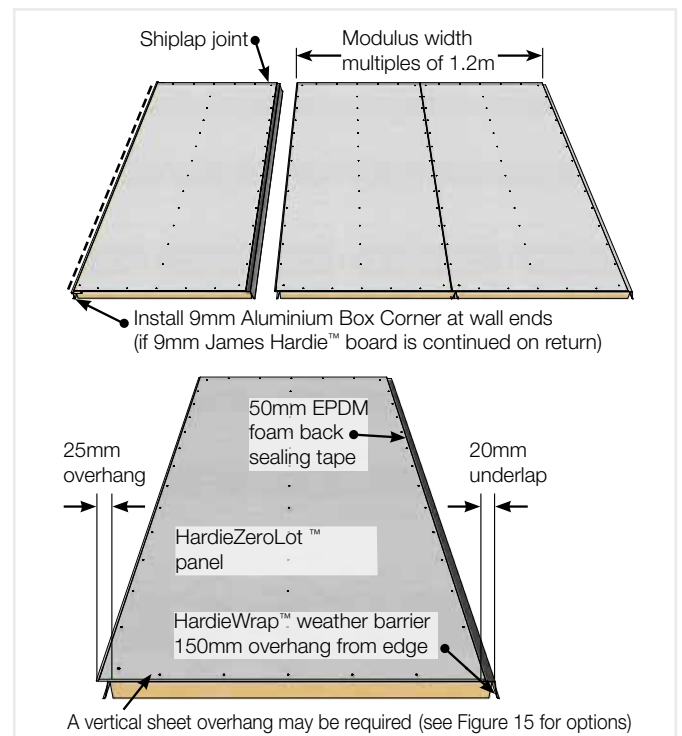

FIGURE 13 HARDIEZEROLOT™ PANEL INSTALLATION

STEP 8 LIFT FIRST WALL MODULE

Wall modules may be lifted manually or by crane (this will depend on the module size and weight). If craning modules into position, the lifting points and connections must be designed by the relevant specialist in accordance with the relevant codes and practices. Ensure to anchor frame to slab as per frame manufacturer recommendations.

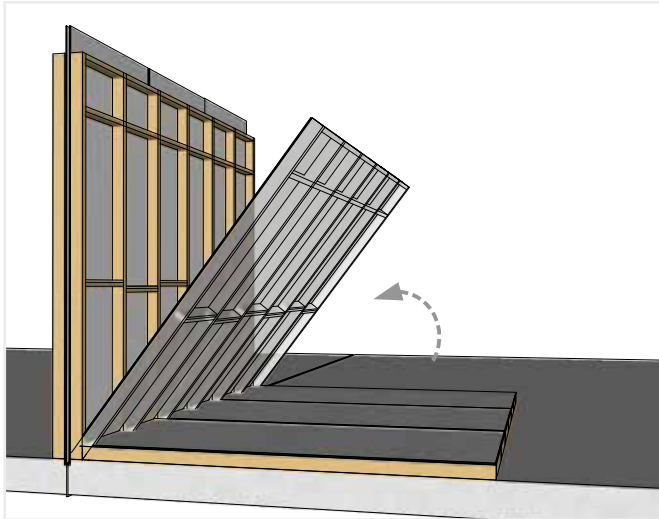

FIGURE 14 LIFT AND ANCHOR - WALL MODULES

STEP 9 TEMPORARY BRACING

Place adequate temporary bracing to ensure lateral restraint of the modules.



FIGURE 15 LIFT AND ANCHOR - WALL MODULES

STEP 10 SUBSEQUENT WALL MODULES

Repeat steps 4-9.

STEP 11 JOINTING WALL MODULES

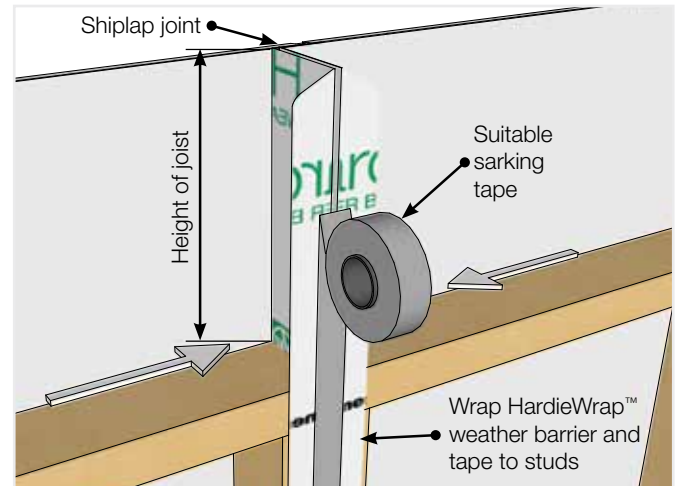

FIGURE 16 VERTICAL JOINT OF WALL MODULES

STEP 12 FLOOR JUNCTION

Place sacrificial timber at the floor junction prior to resting the floor joist on 45mm bearing or fix pole plate to continuous wall.

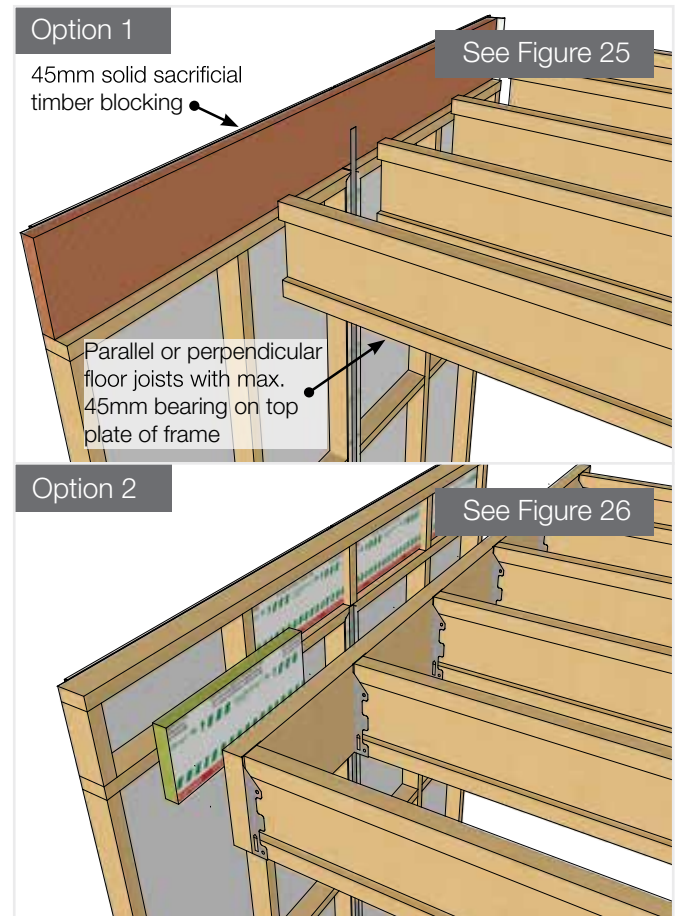

FIGURE 17 INSTALLING FLOOR JOISTS

STEP 13 STEP FLASHING

After the partitions and floor boards have been installed and the upper storey is accessible, fix James Hardie™ Step Flashing to the structural flooring board as indicated below.

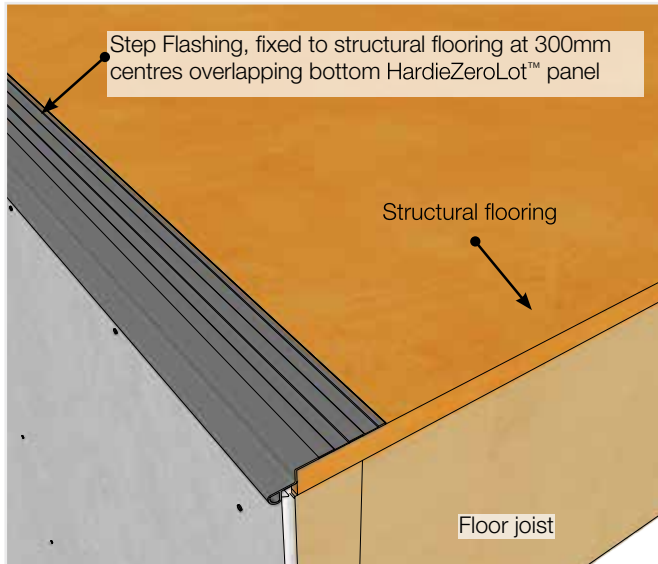

FIGURE 18 INSTALLING STEP FLASHING

STEP 14 UPPER STOREY

Repeat steps 3-11 for the upper storey, note that wall modules must extend to the roof line. Refer to Construction Details for roof options.

STEP 15 ROOF CAVITY

Based on your roof construction detail follow the appropriate detail (See Figures 27-32). Ensure to fix Villaboard™ lining and HardieFire™ insulation prior to fixing the roof trusses to the wall.

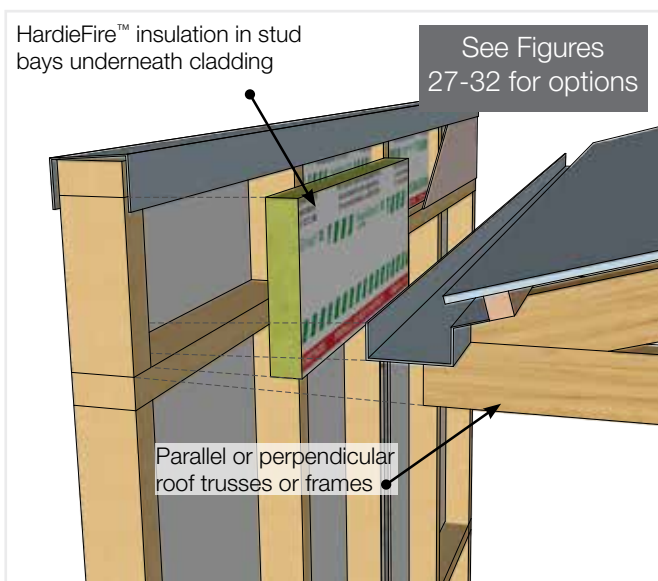

FIGURE 19 ROOF CAVITY FIXING

STEP 16 FIX HARDIEFIRE™ INSULATION

Install the HardieFire™ insulation within stud bays with at least 5mm compression. Avoid joints in insulation batts, if present, all gaps must be filled with compressed HardieFire™ insulation. Push insulation all the way against the HardieWrap™ weather barrier.

ENSURE TO FOLLOW BEST PRACTICE AND WEAR APPROPRIATE PROTECTIVE EQUIPMENT.



FIGURE 20 HARDIEFIRE™ INSTALLATION

STEP 17 INSTALL SERVICES

Services to be run vertically from the ceiling into the wall within the stud bay. If stud drilling is required to allow for pipes or conduits, refer to the Structure and Framing section.

Do not penetrate insulation.



FIGURE 21 INSTALLATION OF SERVICES

STEP 18 FIX VILLABOARD™ LINING

Villaboard™ lining to be installed in accordance with the current installation manual.

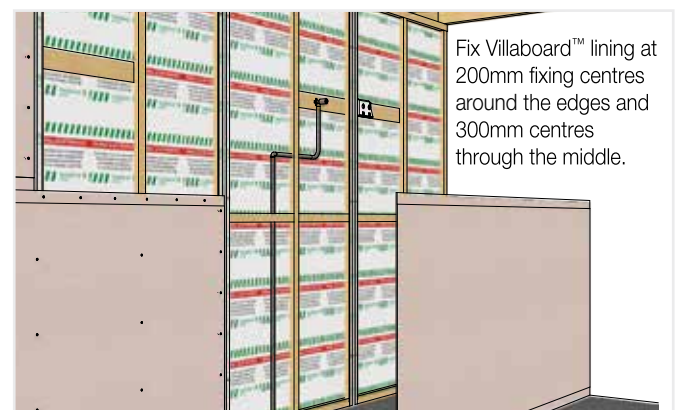

FIGURE 22 VILLABOARD™ LINING INSTALLATION

DETAILS

BASE DETAILS

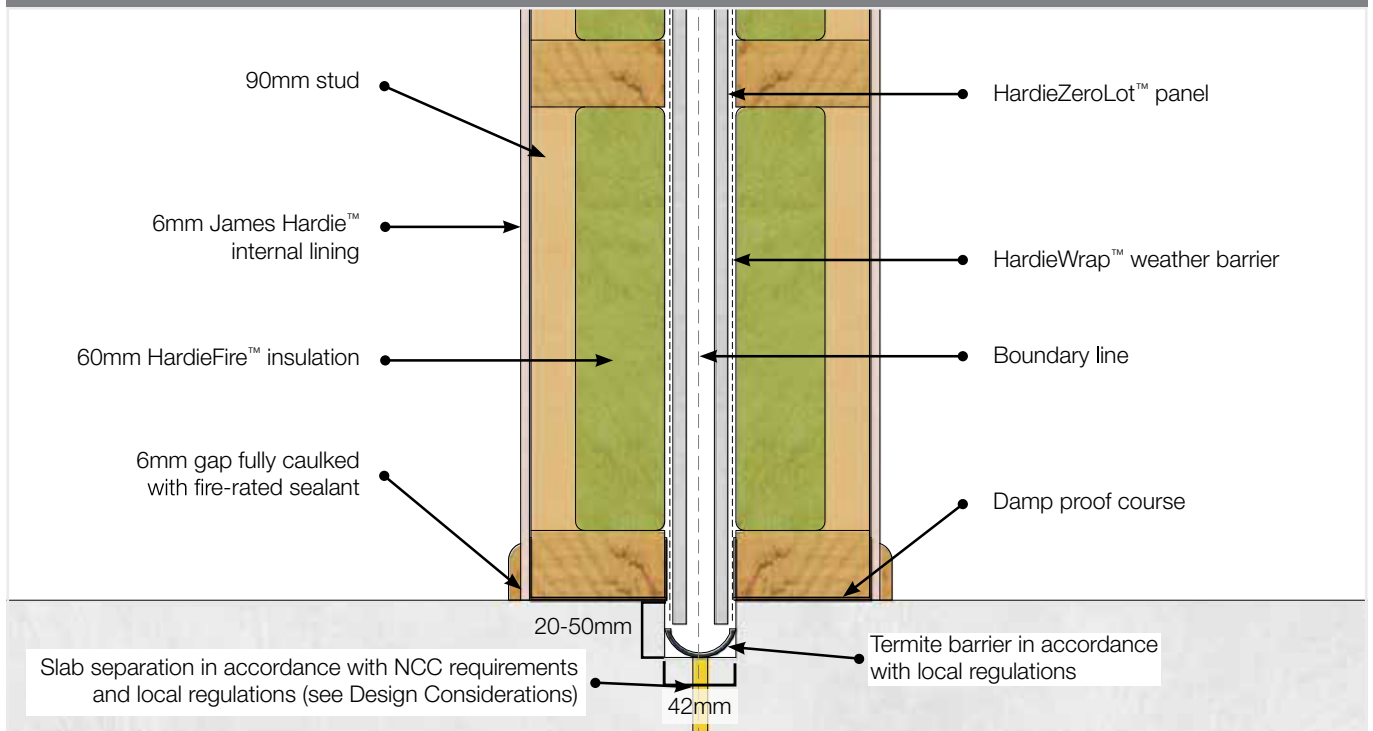

FIGURE 23 SLAB DETAIL FOR DUAL BOUNDARY SYSTEM

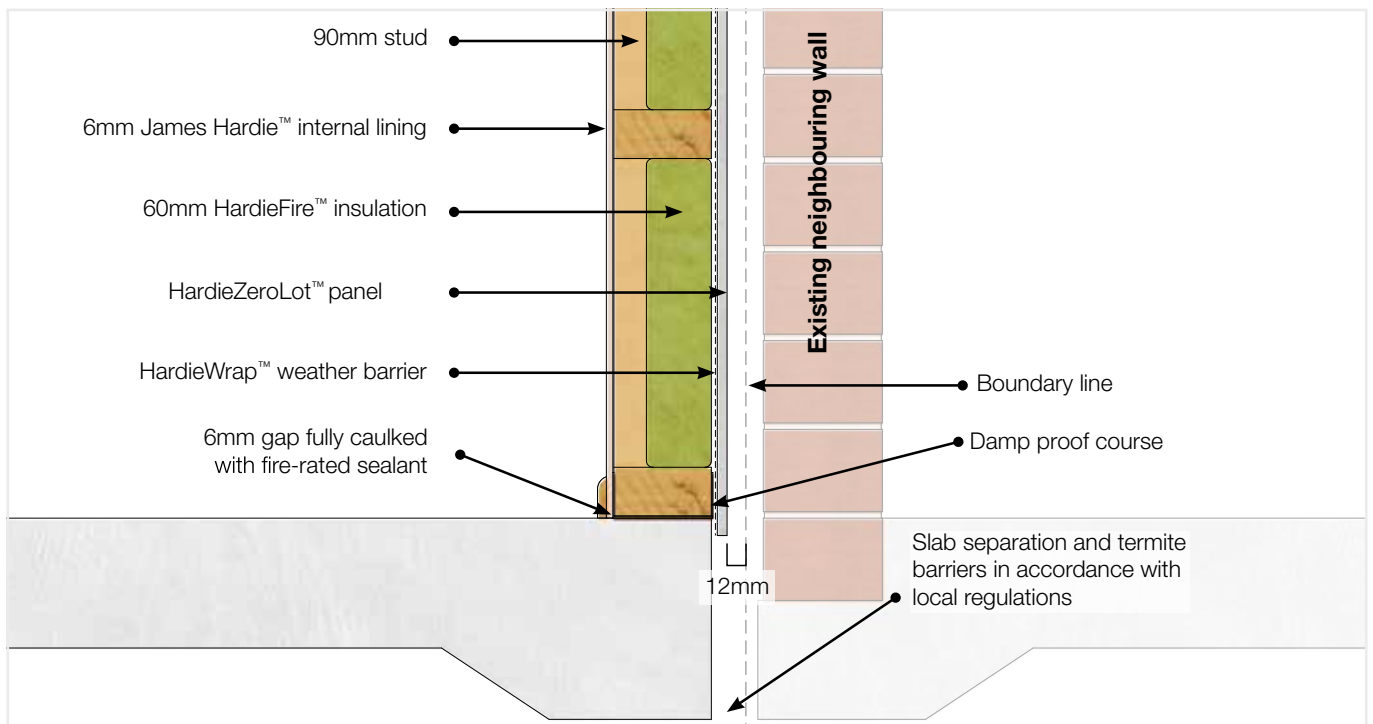

FIGURE 24 SLAB DETAIL FOR SINGLE BOUNDARY

FLOOR JUNCTIONS

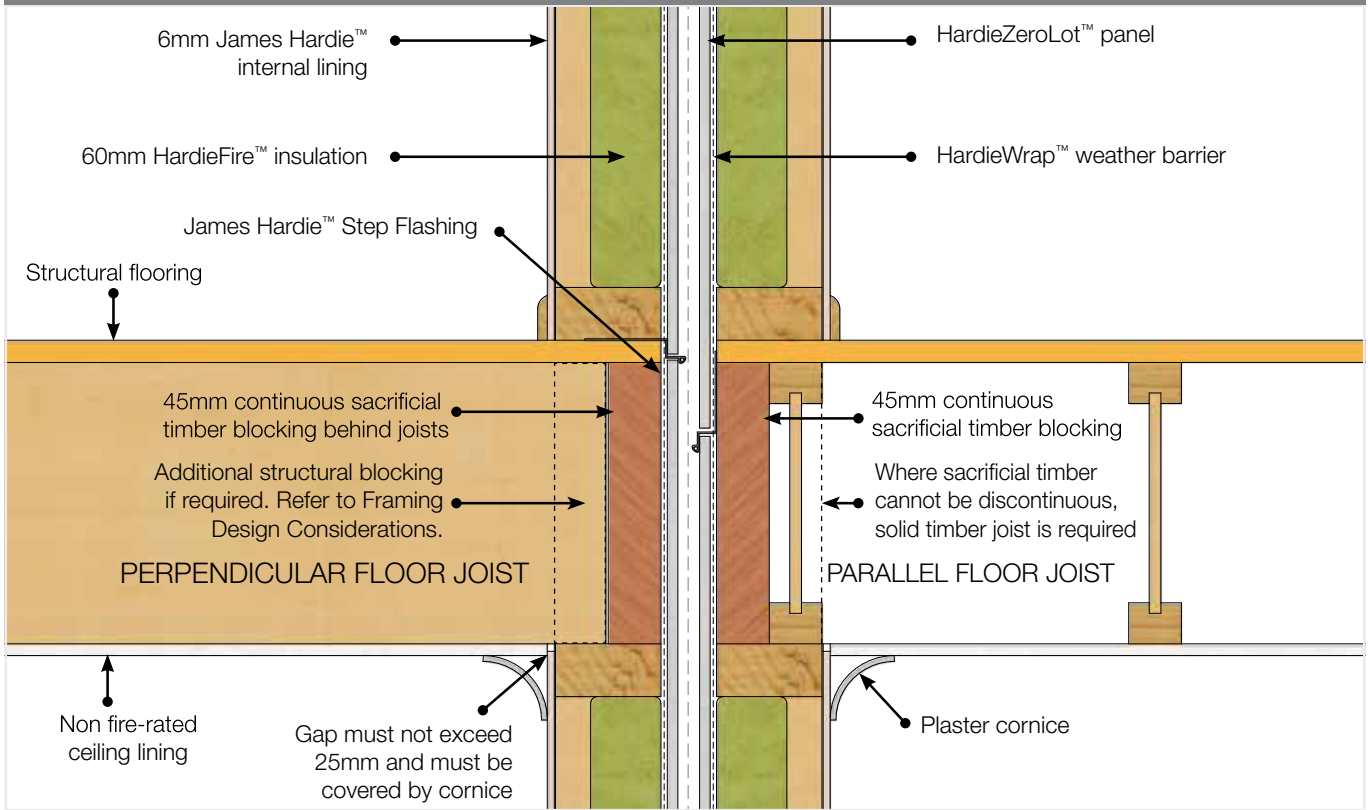

FIGURE 25 DISCONTINUOUS WALL FLOOR JUNCTION (RECOMMENDED)

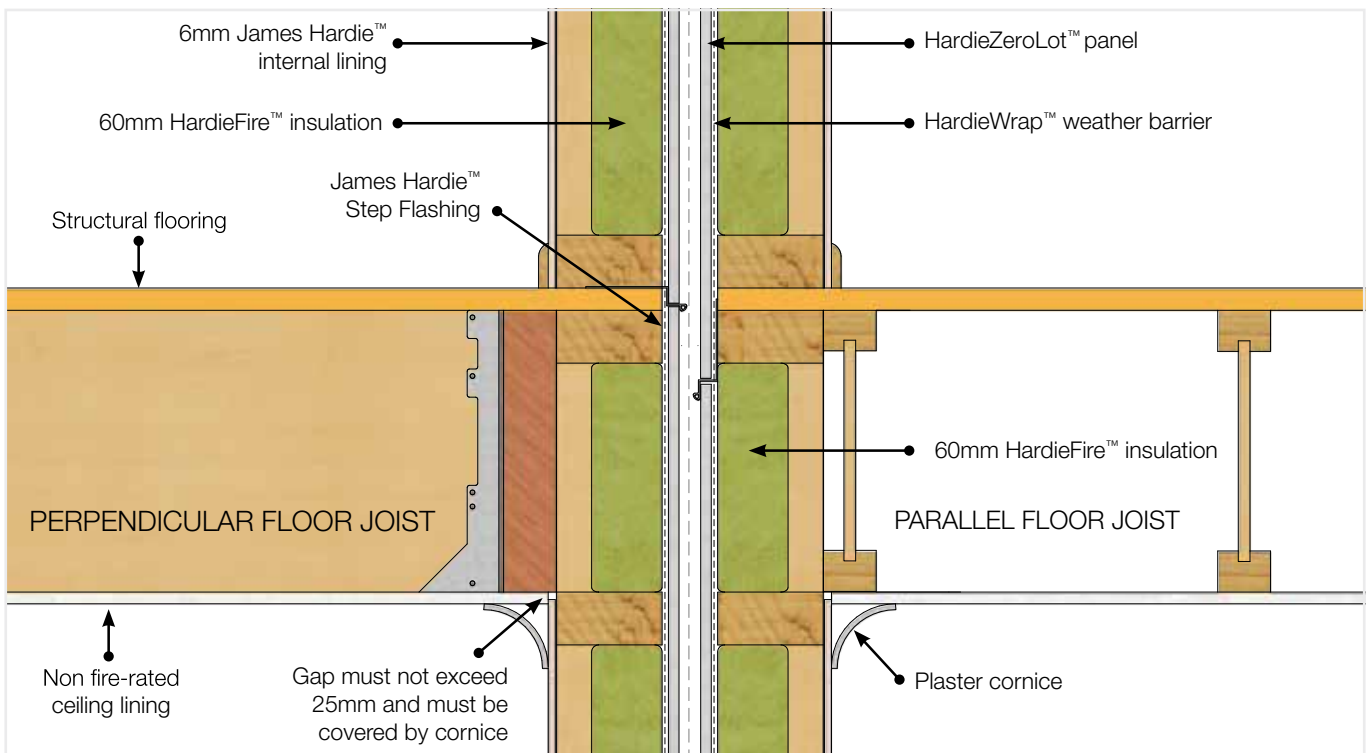

FIGURE 26 CONTINUOUS WALL FLOOR JUNCTION

ROOF DETAILS

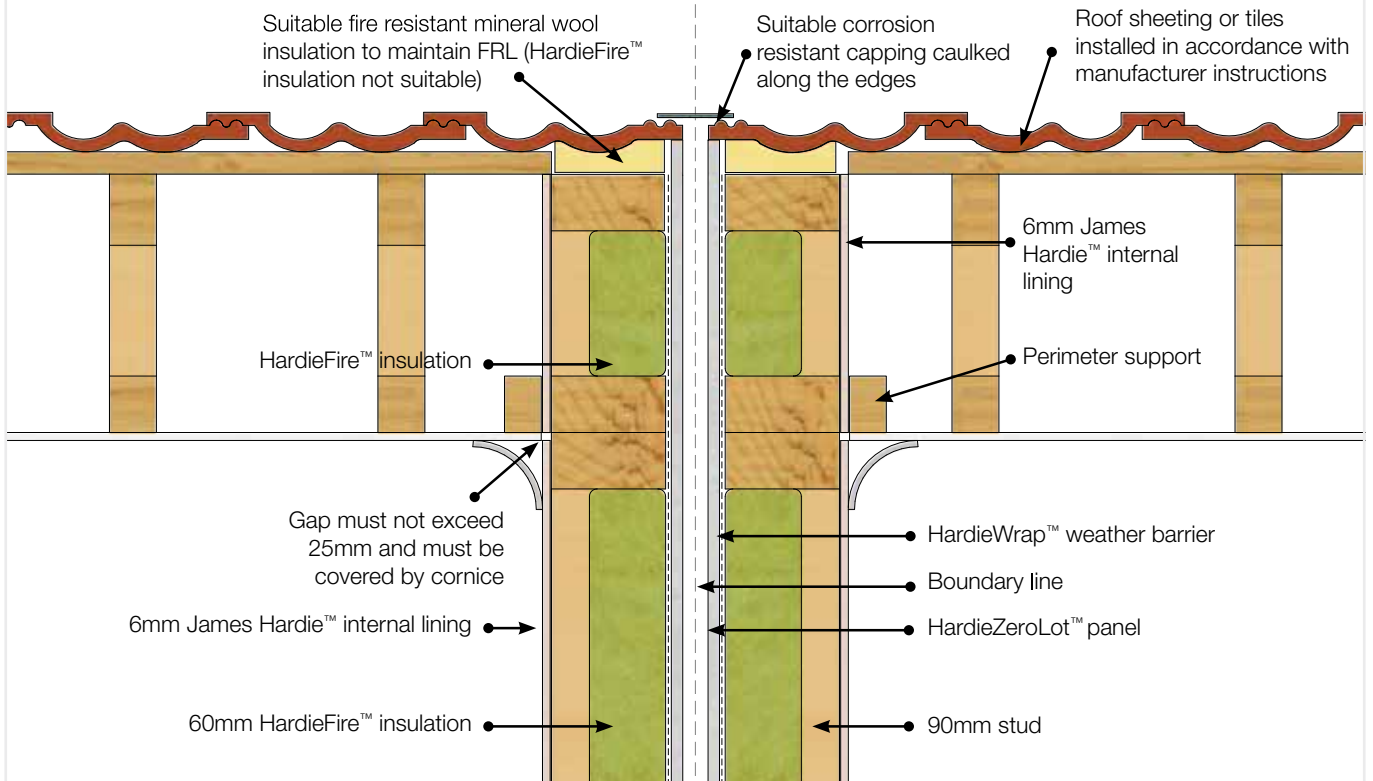

FIGURE 27 DUAL ZERO LOT ROOF WITH PARALLEL ROOF TRUSSES

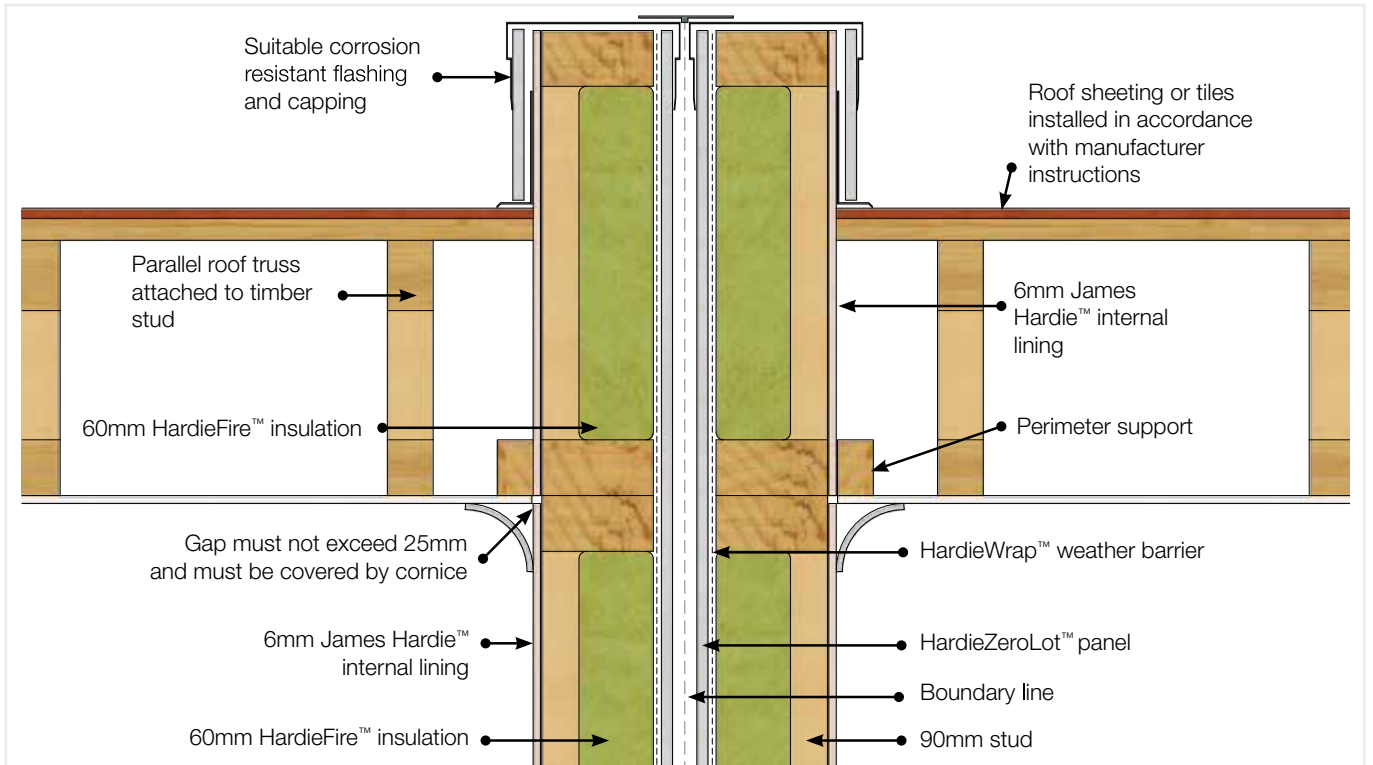

FIGURE 28 DUAL ZERO LOT PARAPET ROOF WITH PARALLEL ROOF TRUSSES

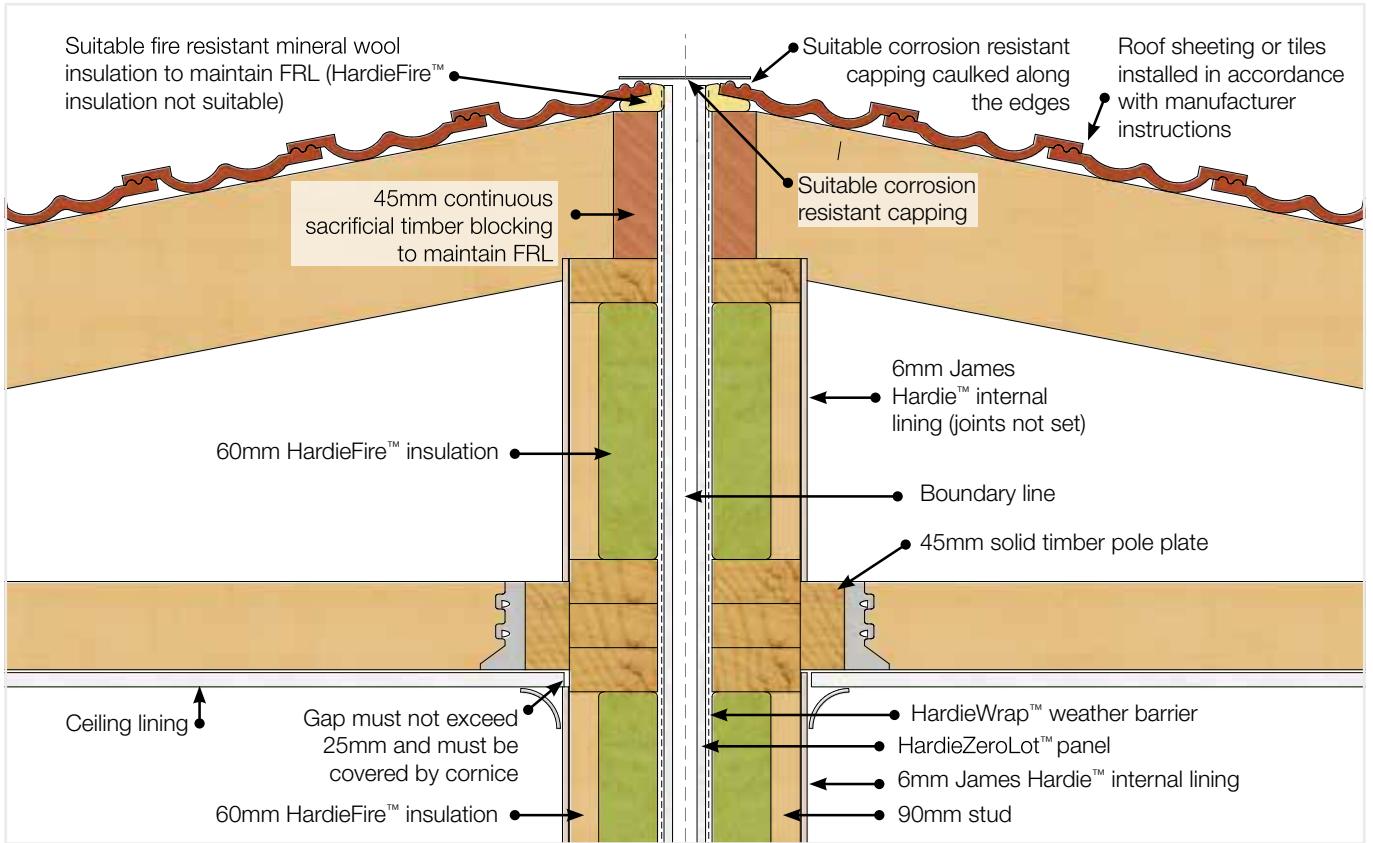

FIGURE 29 DUAL ZERO LOT FRAMED ROOF PERPENDICULAR

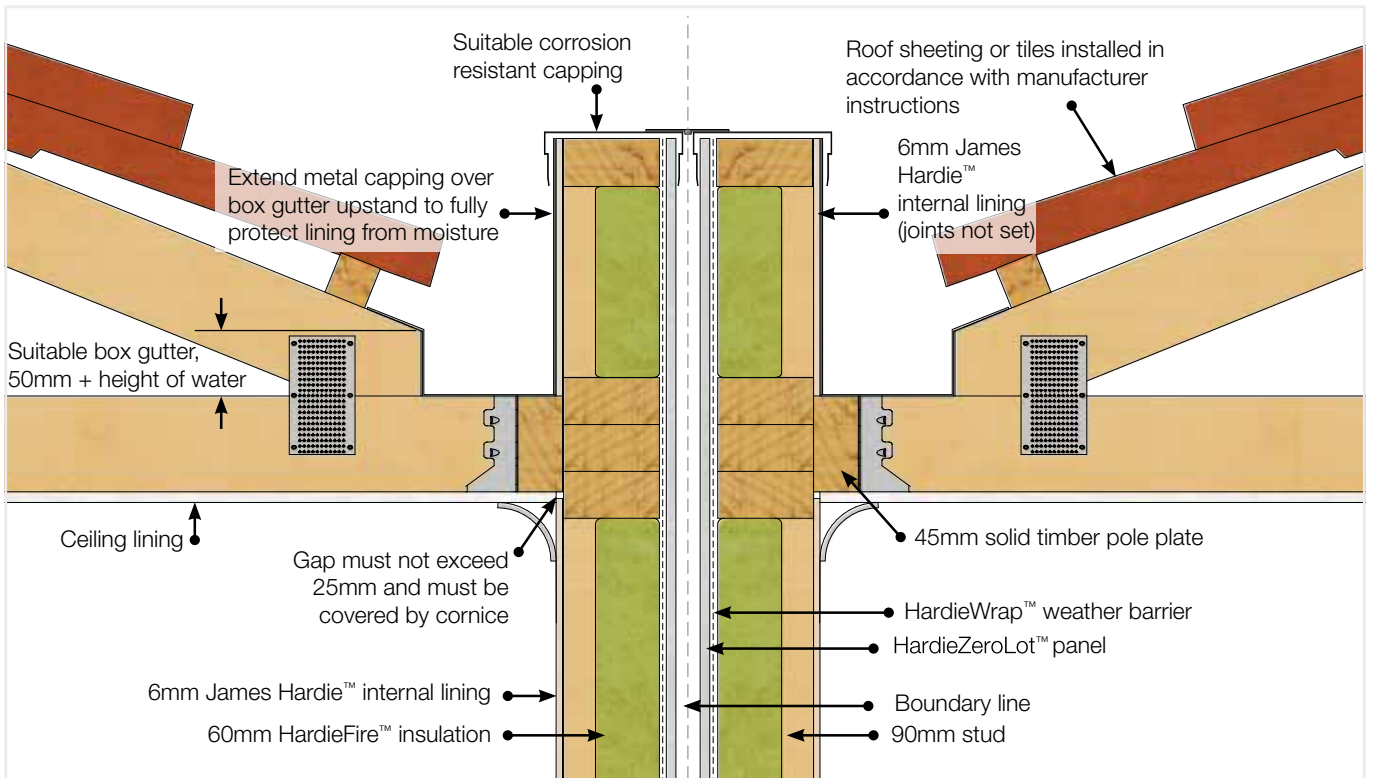

FIGURE 30 DUAL ZERO LOT PARAPET ROOF WITH PERPENDICULAR TRUSSES

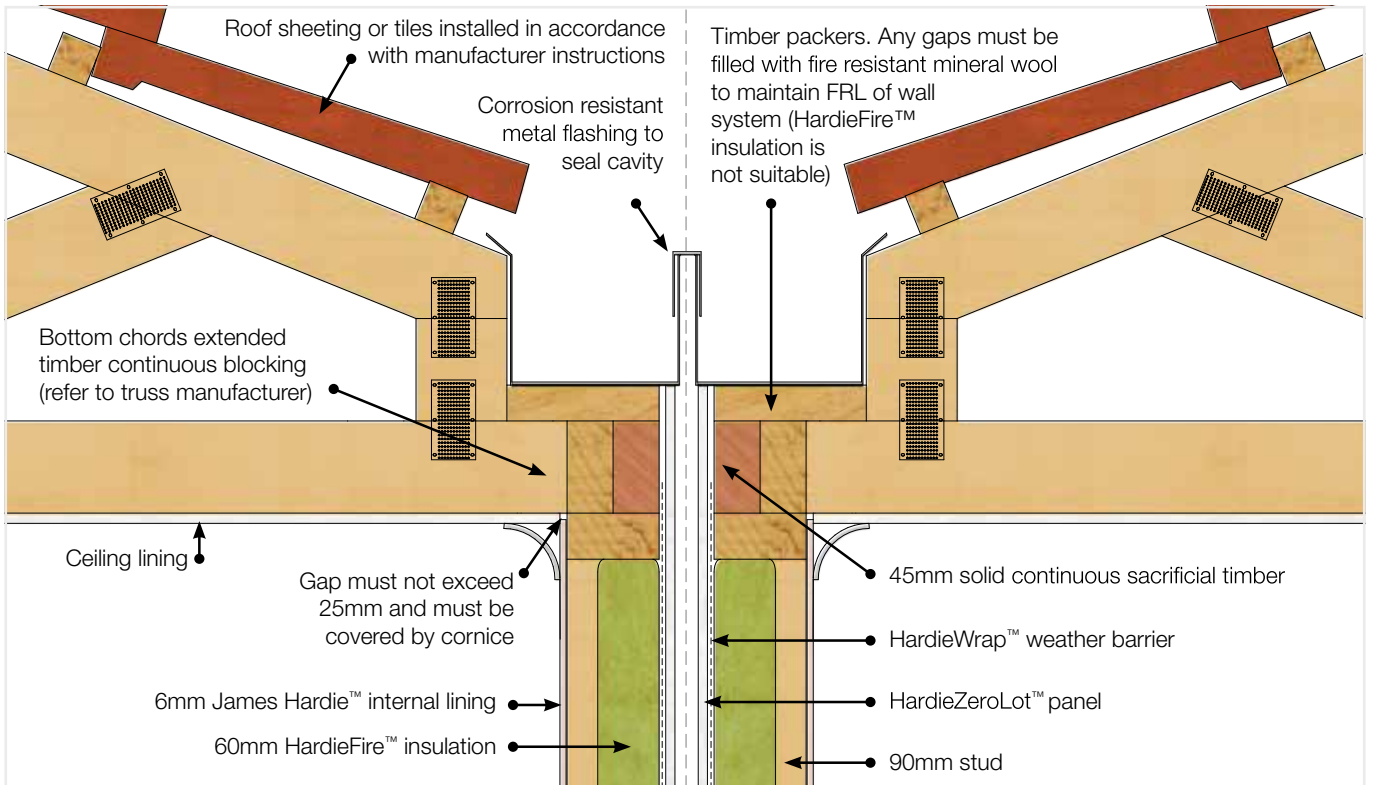

FIGURE 31 DUAL ZERO LOT ROOF WITH PERPENDICULAR TRUSSES AND BOX GUTTER

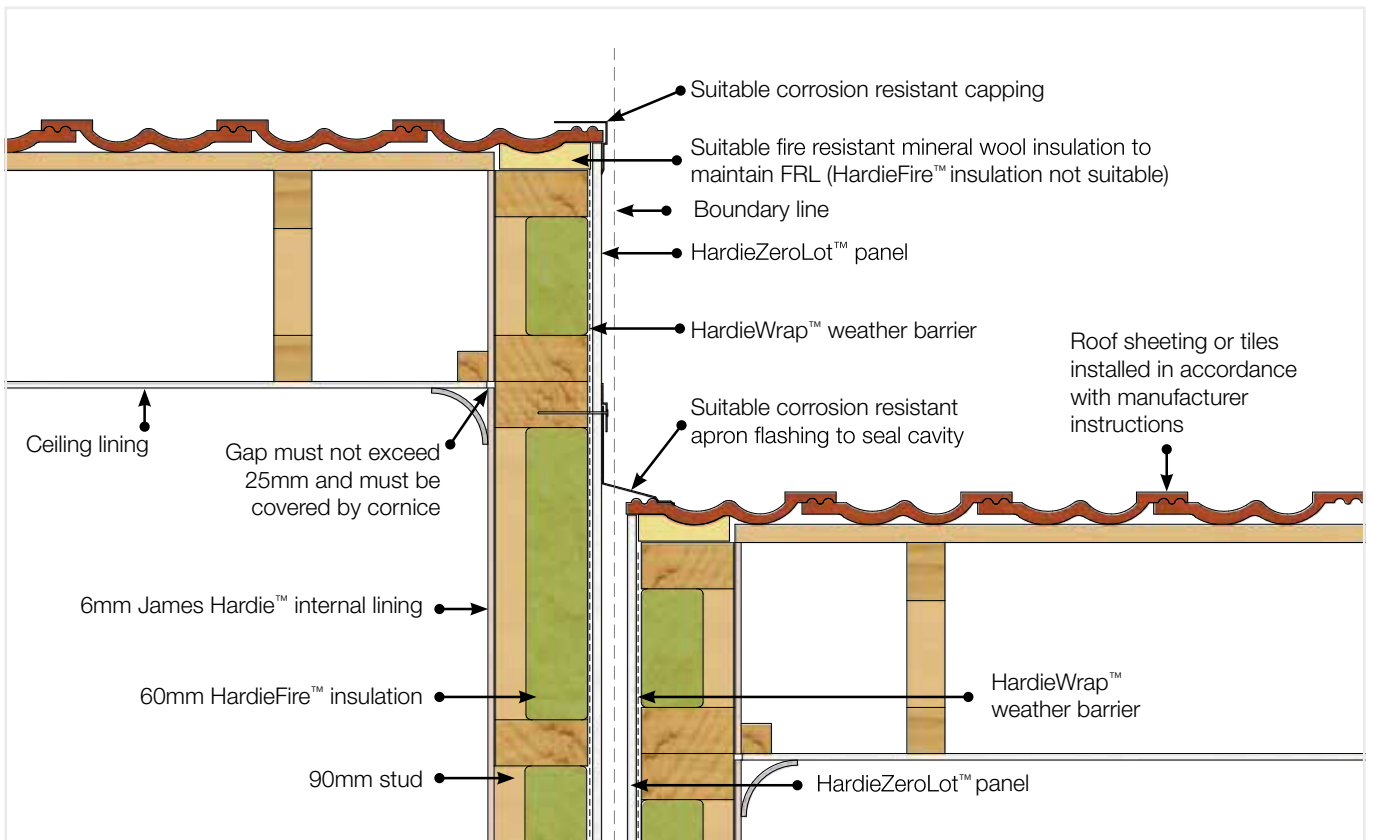

FIGURE 32 DUAL ZERO LOT ROOF AT DIFFERENT HEIGHTS

WALL JUNCTIONS

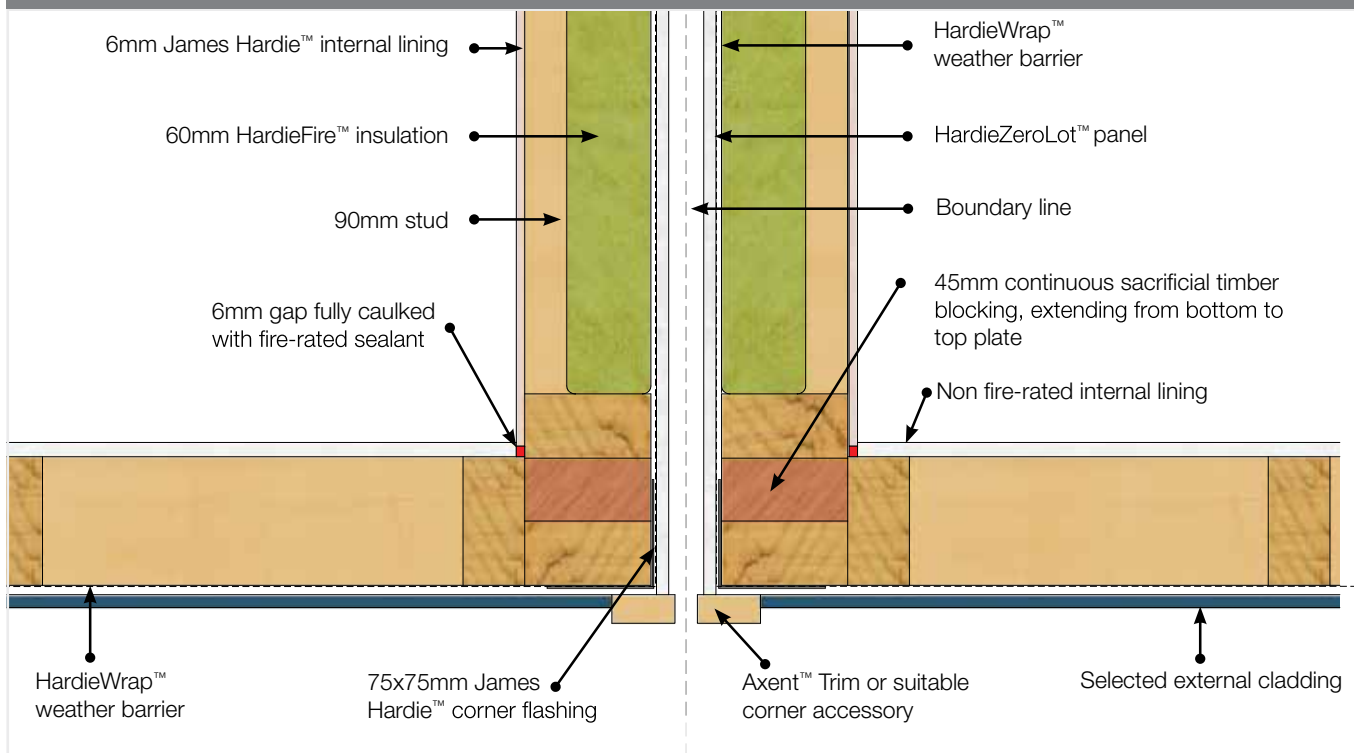

FIGURE 33 JUNCTION WITH LIGHTWEIGHT EXTERNAL WALL

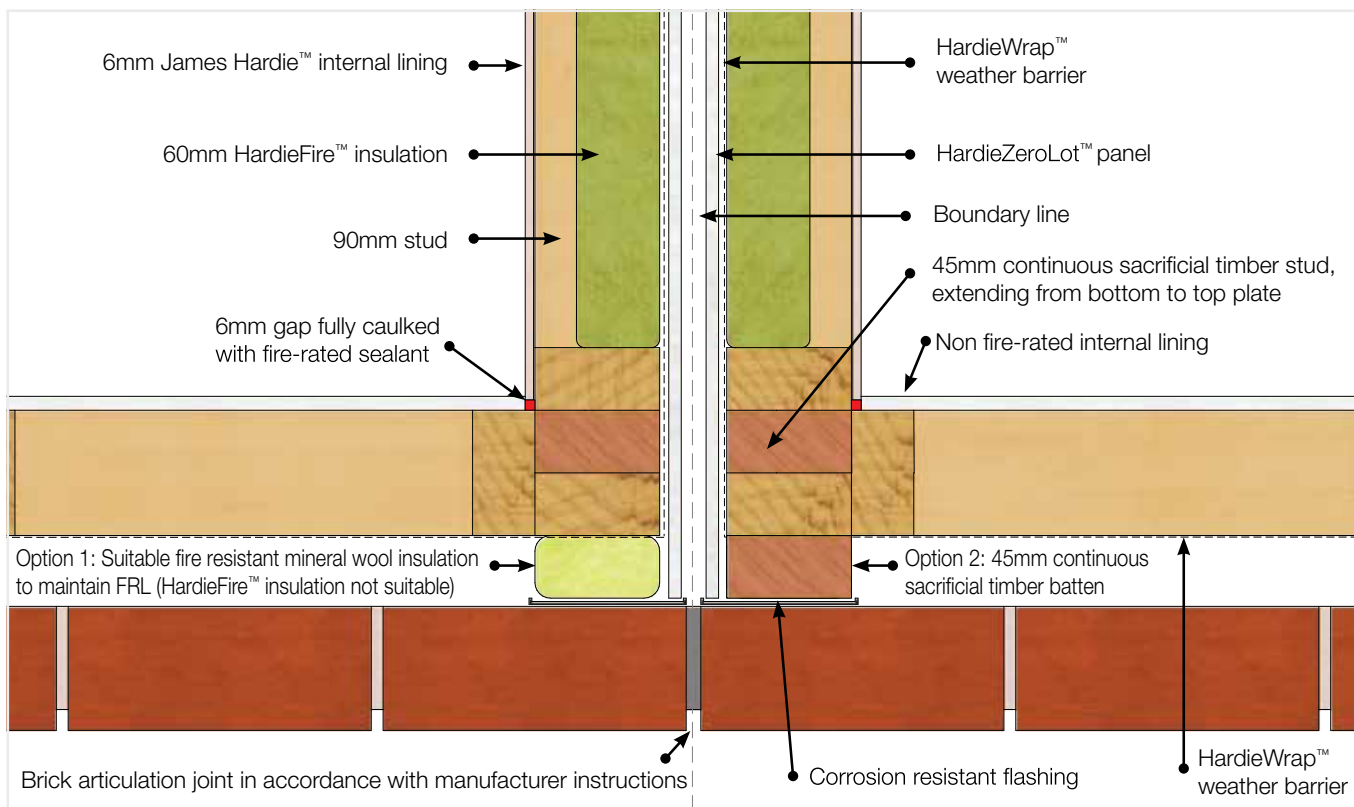

FIGURE 34 JUNCTION WITH BRICK VENEER WALL

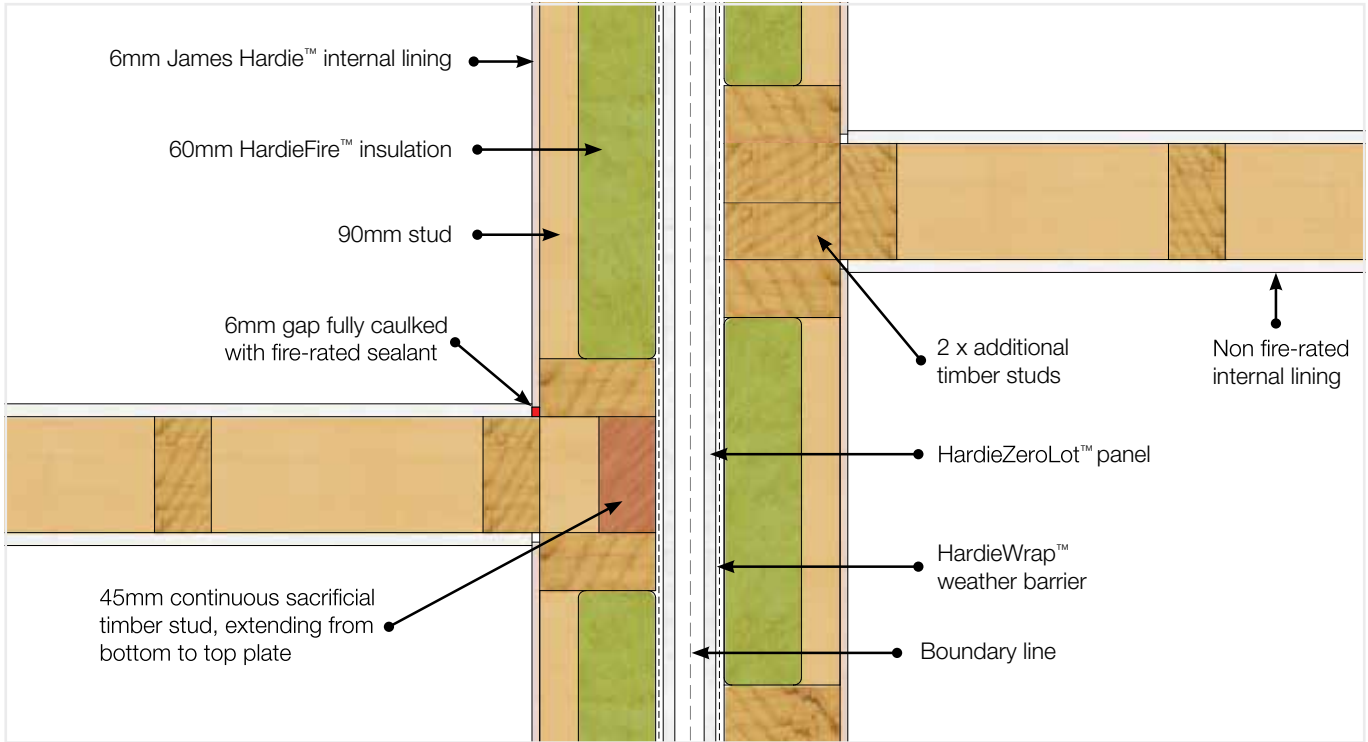

FIGURE 35 INTERNAL NON FIRE-RATED WALL JUNCTION

WALL SERVICES

Refer to Figure 1 Structural and Framing Section for stud and plate penetration limitations

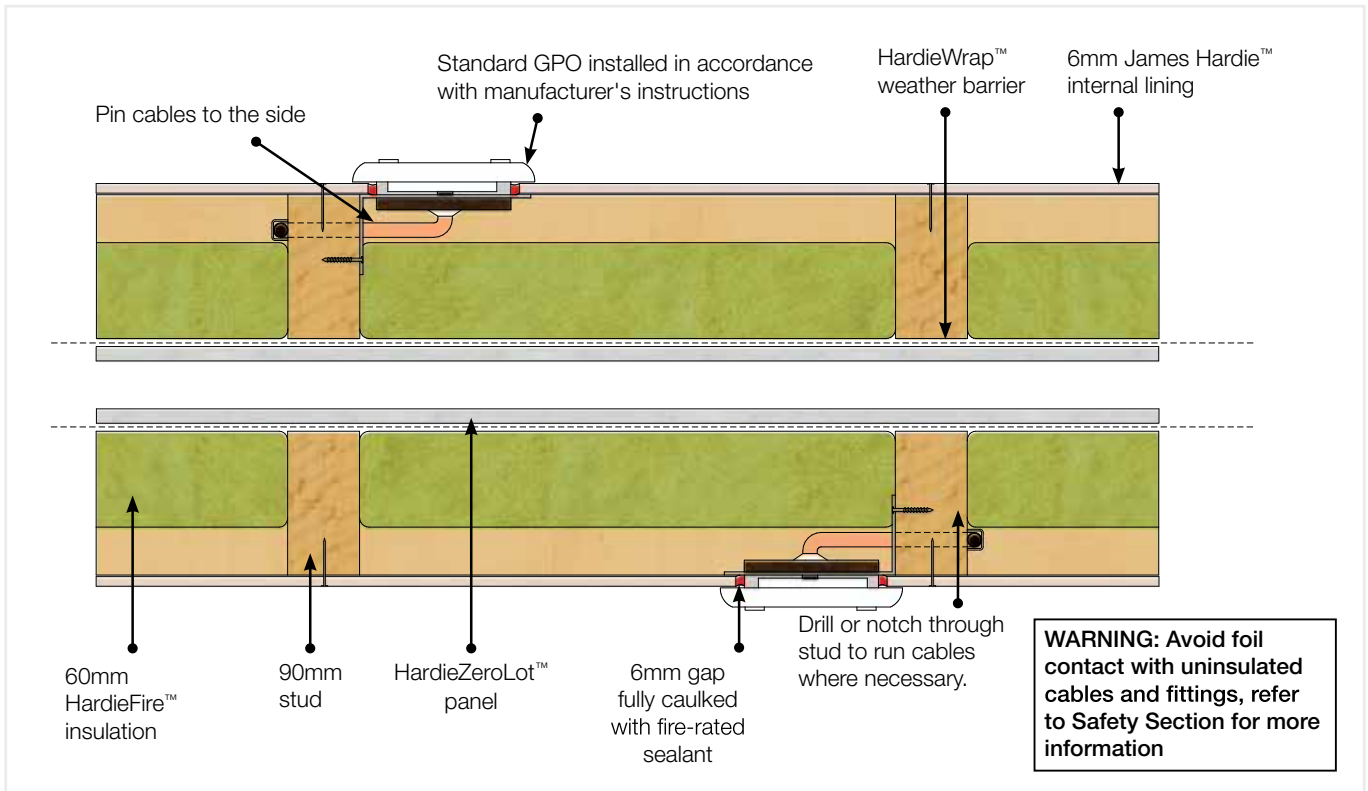

FIGURE 36 ELECTRICAL SERVICES (GPO/POWER POINTS) - SECTION FROM ABOVE

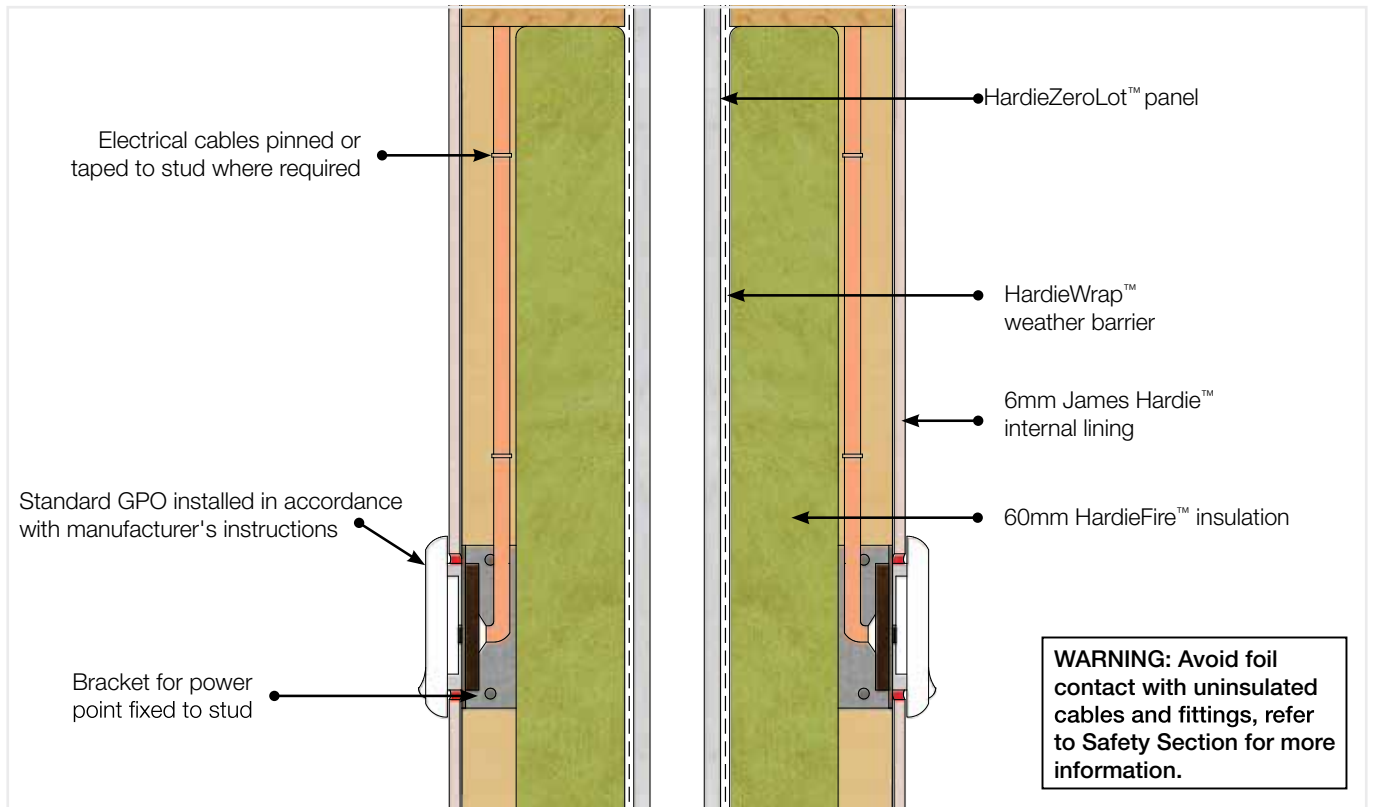

FIGURE 37 ELECTRICAL SERVICES (GPO/POWER POINTS) - SECTION FROM SIDE

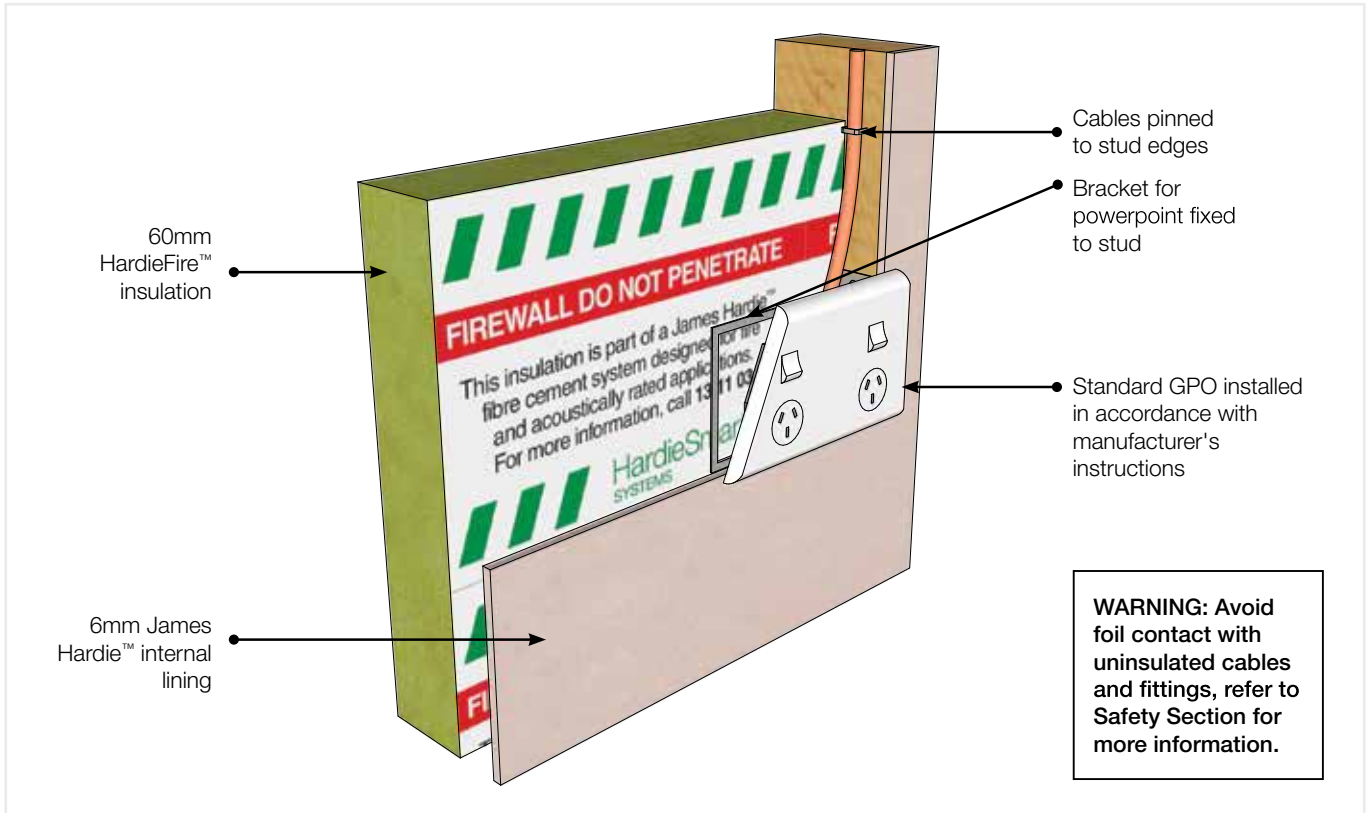

FIGURE 38 ELECTRICAL SERVICES (GPO/POWER POINTS) PERSPECTIVE

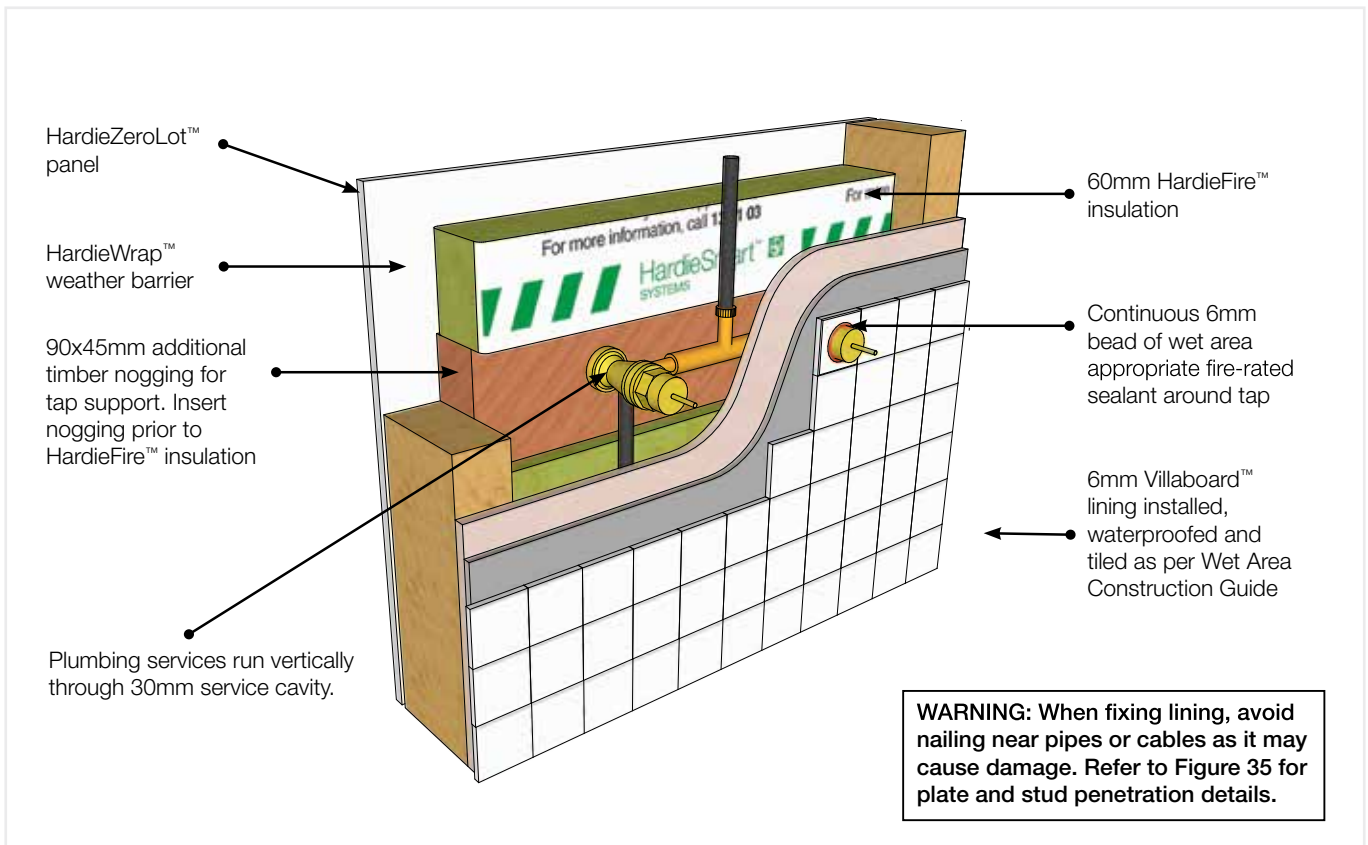

FIGURE 39 HOT/COLD PLUMBING TAPS - PERSPECTIVE

WARNING: When fixing lining, avoid nailing near pipes or cables as it may cause damage. Refer to Figure 35 for plate and stud penetration details.

Continuous 6mm bead of wet area appropriate fire-rated sealant around tap

6mm Villaboard™ lining installed, waterproofed and tiled as per Wet Area Construction Guide

Refer to Figure 35 for drill hole size and location

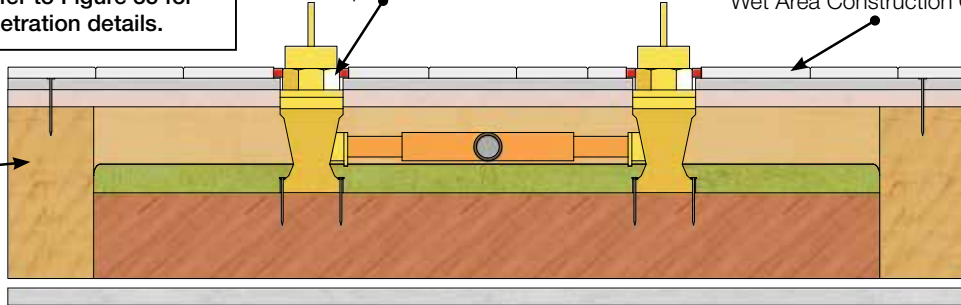

90x45mm additional timber noggin for tap support. Insert nogging prior to HardieFire™ insulation

Plumbing services run through 30mm service cavity

HardieWrap™ weather barrier

HardieZeroLot™ panel

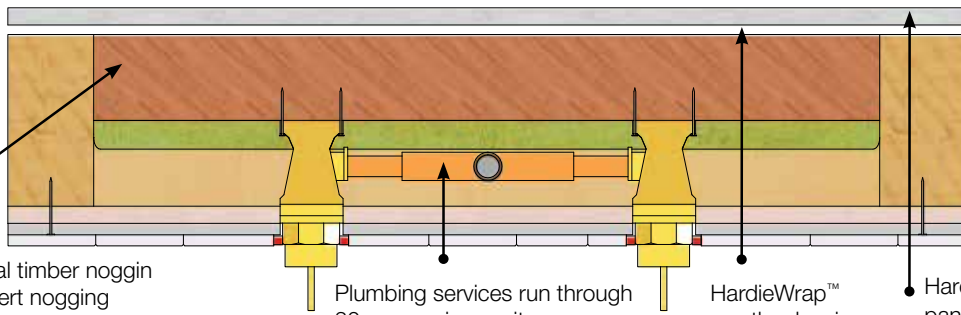

FIGURE 40 HOT/COLD PLUMBING TAPS - SECTION FROM ABOVE

WARNING: When fixing lining, avoid nailing near pipes or cables as it may cause damage. Refer to Figure 35 for plate and stud penetration details.

6mm Villaboard™ lining installed, waterproofed and tiled as per Wet Area Construction Guide

90x45mm additional timber nogging for tap support. Insert nogging prior to HardieFire™ insulation

Plumbing services run vertically through 30mm service cavity.

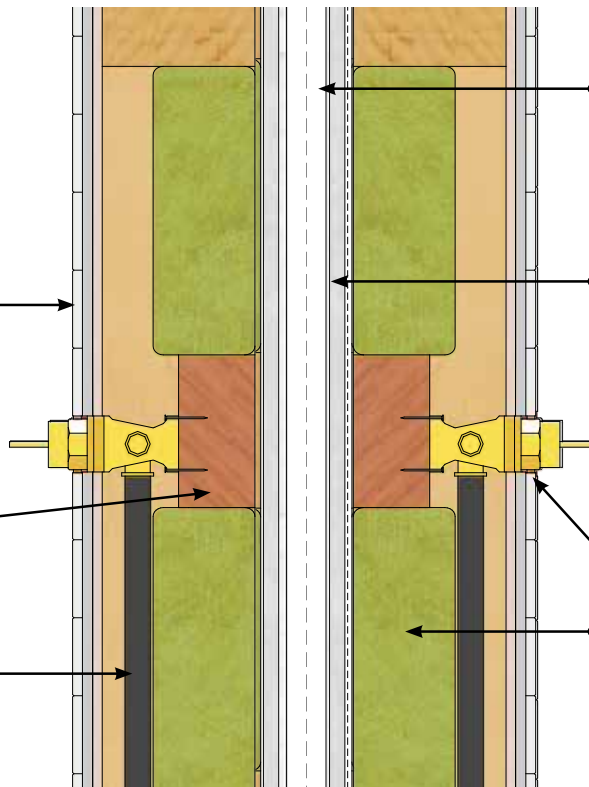

HardieZeroLot™ panel

HardieWrap™ weather barrier

Continuous 6mm bead of wet area appropriate fire-rated sealant around tap

60mm HardieFire™ insulation

FIGURE 41 HOT/COLD PLUMBING TAPS - SECTION FROM SIDE

ONLINE TOOLS

Estimation tools, CAD details, and site specific documents are available via our specification website accel.com.au. For more information visit the website or Ask James Hardie™ on 13 11 03.

WARRANTY

HardieSmart™ Wall System components supplied by James Hardie are backed by a Warranty. The Warranty period will vary based on the specific system component. For Warranty Terms & Conditions refer to www.jameshardie.com.au or Ask James Hardie™ on 13 11 03.

CODEMARK CERTIFICATION



SITE INSTALLATION CHECKLIST

BACKGROUND

Date: _____ Installer: _____

Project Address: _____

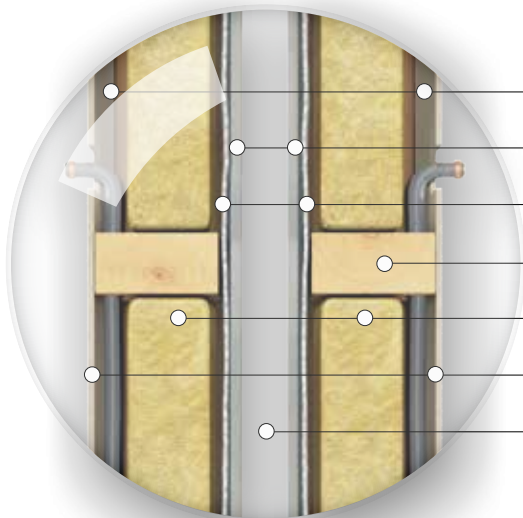

- 30mm cavity for services**
- HARDIEZEROLOT™ panels**
- HardieWrap™ weather barrier**
- 90mm timber stud wall**
- 60mm HardieFire™ insulation**
- James Hardie™ internal lining (6mm or thicker)**
- Min. 25mm cavity**

SCOPE

The purpose of this check list is to help deliver a quick, low fuss successful installation of HardieSmart™ ZeroLot™ wall system and assist in identifying areas of non-compliance with the design guide current at the time of installation.

This form has been categorised in four inspections to ensure compliance:

1. Framing Stage
2. Insulation Stage
3. Services Stage
4. Lining Stage

All references made in this document refer to the latest HardieSmart™ ZeroLot™ wall system Design Guide available at www.jameshardie.com.au.

INSPECTIONS	CARRIED BY	DATE	SIGNATURE
FRAMING*			
INSULATION			
SERVICES*			
INTERNAL LINING*			

*Optional Inspections

FRAMING INSPECTION (OPTIONAL)

Date: _____ Completed by: _____ Signature: _____

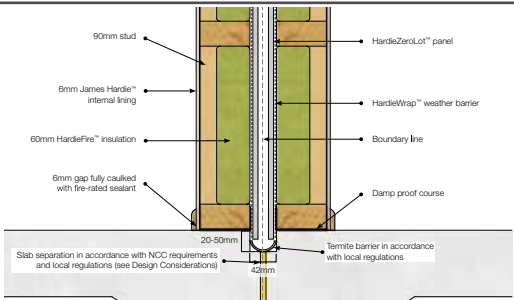
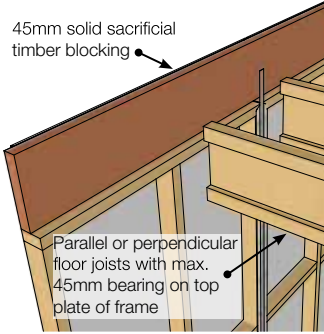
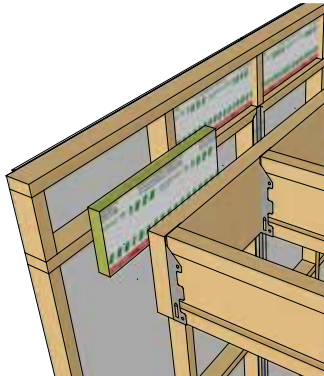
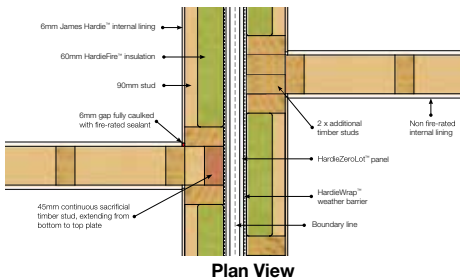

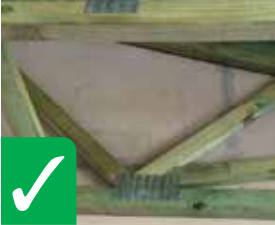
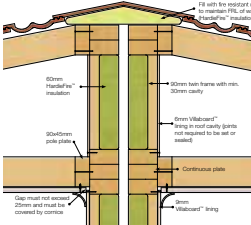

ITEM	SUB-ITEM	REQUIREMENT	YES	NO	COMMENTS
FRAMING ATTRIBUTES	Depth (mm)	90	<input type="checkbox"/>	<input type="checkbox"/>	
	Width (mm)	45 or 35	<input type="checkbox"/>	<input type="checkbox"/>	
	Stud Spacing (mm)	Not to exceed 600mm			
	Material	Timber			
SLAB	Slab separation		<input type="checkbox"/>	<input type="checkbox"/>	Full slab separation between dwellings required in accordance with BCA and regulations.
FLOOR JUNCTIONS	Additional Timber Batten	<p>Upper storey floor option 1: solid 45mm timber beam runs continuously along wall with joist ending half way across wall frame. Figure 25</p> 	<input type="checkbox"/>	<input type="checkbox"/>	
		<p>Upper storey floor option 2: solid 45mm timber plate along wall with joist ending against wall frame. Figure 26</p> 	<input type="checkbox"/>	<input type="checkbox"/>	
WALL JUNCTIONS	Additional Timber Batten	<p>Continuous 45mm solid timber sacrificial stud at wall junction</p>  <p style="text-align: center;">Plan View</p>	<input type="checkbox"/>	<input type="checkbox"/>	

FRAMING INSPECTION (CONT.)

ITEM	SUB-ITEM	REQUIREMENT	YES	NO	COMMENTS
ROOF JUNCTIONS	Wall continuity at the roof junction	Ensure wall system continues at the roof junction with Villaboard® lining and HardieFire™ insulation. See options: Figures 26-31  	<input type="checkbox"/>	<input type="checkbox"/>	
		Example of Villaboard™ lining, cladding over HardieFire™ extending to underside of roof lining			

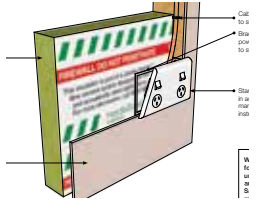
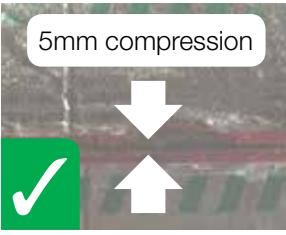
INSULATION INSPECTION

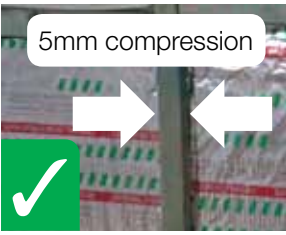
Date: _____ Completed by: _____ Signature: _____

ITEM	SUB-ITEM	REQUIREMENT	YES	NO	COMMENTS
CHARACTERISTICS	Brand	HardieFire™ Insulation	<input type="checkbox"/>	<input type="checkbox"/>	
	Depth	60mm	<input type="checkbox"/>	<input type="checkbox"/>	
ELECTRICAL SERVICES	Cables	Cables are pinned to the stud edges 	<input type="checkbox"/>	<input type="checkbox"/>	Electrical cables should be pinned to stud edge around perimeter of bay. Do not penetrate HardieFire™.
COMPRESSION Ensure 5mm compression throughout, no gaps.	Insulation Joints	 	<input type="checkbox"/>	<input type="checkbox"/>	If any gaps, it must be filled with HardieFire™ Insulation.
	Edges with frame		<input type="checkbox"/>	<input type="checkbox"/>	
	Gaps	Fill gaps with HardieFire™ Insulation 	<input type="checkbox"/>	<input type="checkbox"/>	

SITE INSTALLATION CHECKLIST

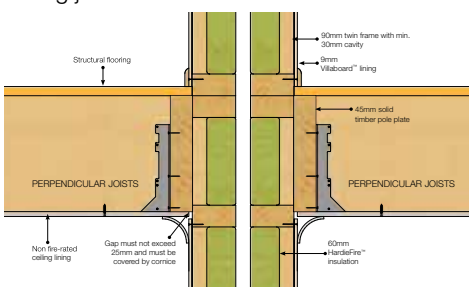
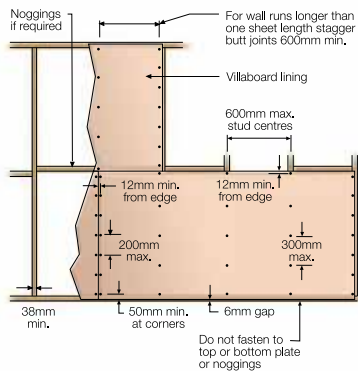
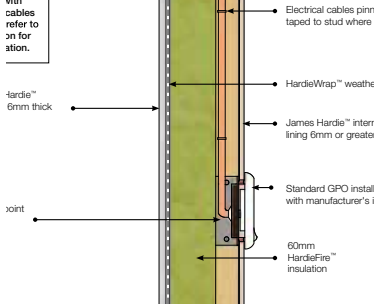
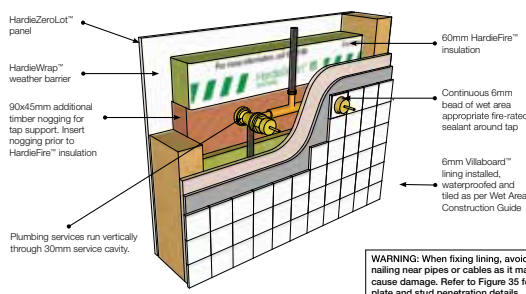
LINING INSPECTION (OPTIONAL)					
ITEM	SUB-ITEM	REQUIREMENT	YES	NO	COMMENTS
CHARACTERISTICS	Lining	Villaboard® lining (6, 9 or 12mm) Versilux® lining (6 or 9mm) HardieGroove™ lining	<input type="checkbox"/>	<input type="checkbox"/>	
BASE JUNCTION	Concrete Slab Junction	To maintain acoustic properties, fire and acoustic sealant required along the perimeter of wall and the slab junction	<input type="checkbox"/>	<input type="checkbox"/>	
CEILING JUNCTION	Cornice and Lining Junction	Gap at the ceiling junction not to exceed 25mm 	<input type="checkbox"/>	<input type="checkbox"/>	
LINING	Orientation	Vertical or Horizontal If used for Bracing, it must be vertical	<input type="checkbox"/>	<input type="checkbox"/>	
	Fastening		<input type="checkbox"/>	<input type="checkbox"/>	If using tiles, fastening centres are reduced to 200mm everywhere and tile weight may reduce stud centres. Refer to Villaboard® lining manual.
PENETRATIONS	General Power Outlets and other boxes	Figures 36-38 	<input type="checkbox"/>	<input type="checkbox"/>	Standard GPO may be used.
	Plumbing and others	Plumbing run within the 30mm cavity. Figures 39-41  <small>WARNING: When fixing lining, avoid nailing near pipes or cables as it may cause damage. Refer to Figure 35 for plate and stud penetration details.</small>	<input type="checkbox"/>	<input type="checkbox"/>	To maintain acoustic properties, wet area fire and acoustic sealant required around tap and other penetrations through the Villaboard™.



**For information and advice
call 13 11 03 | jameshardie.com.au**

Australia May 2019



© 2019 James Hardie Australia Pty Ltd ABN 12 084 635 558
™ and © denote a trademark or registered mark owned by James Hardie Technology Limited.