

WORKING WITH SKY-FRAME.

EN



SKY-FRAME

**A VIEW,
NOT A
WINDOW.**















Working with Sky-Frame means creating living environments of unparalleled beauty, comfort and elegance. The frameless sliding window is a modular system that combines Swiss engineering ingenuity with timeless style, resulting in architectural elements that exude quality in every regard.



SKY-FRAME

SKY-FRAME SYSTEM.

The various systems can be combined with glass panels of different thicknesses and thus provide an aesthetically pleasing solution with a range of useful functions. As soon as you have chosen the ideal system, the appropriate glazing can be selected. You can further tailor your system with a wide selection of additional features.

		CLASSIC Straight sliding doors	ARC Curved sliding doors	SLOPE Inclined sliding doors	PIVOT Pivot door
OPTION Track system	 Original Visible transition	●	●	*	
	 Plain* Hidden, seamless transition	*			
TECHNOLOGY Glazing	 Sky-Frame 1 Single glazing	○			
	 Sky-Frame 2 Double-glazed insulating glass	●	○	*	*
	 Sky-Frame 3 Triple-glazed insulating glass	●	○	*	*
FEATURES	 Fly Insect screen	●			
	 Drive Electric drive	●	*	*	
	 Guard Increased anti-burglary protection	●	*	*	*
	 Pocket Hidden sliding window	●	○	*	
	 Inline Flush-fitted glass panels	●	*	*	
	 Gun* Bulletproof version	○			
	 Sun* Shading solution	●			
	 Hurricane	○			
	 Color Customisation	●	●	●	●

● standard ○ only with the Original option * on request

SYSTEM

Sky-Frame Classic

The rectilinear Classic window system has timeless appeal. True to the Bauhaus vision, the ceiling-height glass facades help to create a minimalist architecture in which the view takes centre stage.

For technical details, see page 06.

Sky-Frame Arc

The organic forms of the Arc model serve to soften the contours of domestic architecture. The curved sliding panels offer a bold counterpoint to the linearity of the spatial and facade composition.

For technical details, see page 08.

Sky-Frame Slope

The Slope system allows the sliding windows to be installed at an angle. The inclined glass units can either extend into the room or project outwards from the facade. The distinctive spatial geometry offers a unique living experience.

For technical details, see page 10.

Sky-Frame Pivot

Thanks to its asymmetrically positioned axis, Sky-Frame Pivot, the glass-panelled pivot door, swings open easily with just a gentle push. The multipoint locking system guarantees safety and security.

For technical details, see page 12.

OPTION

Sky-Frame Original

A feeling of vast, wide-open space, even when the windows are shut: the windows are framelessly transparent from the ceiling to the floor, which is made possible by the track system that is fully concealed in the floor. Sky-Frame Original ensures that heat and cold remain outside.

For technical details, see page 14.

Sky-Frame Plain

What sets Sky-Frame Plain apart is the hidden, seamless transition between the inside and the outside that is completely flush-fitted with the floor. The sliding door glides along a narrow gap and is fitted flush with the floor. The space between these tracks is covered by the same flooring as the interior of the room, which reinforces the feeling of a free-flowing transition between indoors and outdoors.

For technical details, see page 16.

TECHNOLOGY

Sky-Frame 1

The single-glazed Sky-Frame 1 system (12 mm) is suitable for applications without thermal insulation requirements.

For technical details, see page 20.

Sky-Frame 2

The double-glazed Sky-Frame 2 assemblies (30 mm) meet strict sound and thermal control requirements.

For technical details, see page 22.

Sky-Frame 3

The triple-glazed Sky-Frame 3 technology (54 mm) further enhances the thermal insulation performance to meet the most stringent standards.

For technical details, see page 24.

FEATURES

Sky-Frame Fly

Sky-Frame Fly makes it possible to enjoy summer weather without being plagued by insects. When not in use, the pleated screen fully retracts out of sight into the frame.

For technical details, see page 26.

Sky-Frame Drive

The electric drive facilitates straightforward and virtually noiseless operation of the sliding panels at the press of a button.

For technical details, see page 28.

Sky-Frame Guard

The Sky-Frame sliding window system is burglar-resistant and can, where required, be fitted with laminated safety glass and additional security hardware concealed in the frame. Alarm sensors can also be integrated to monitor the windows.

For technical details, see page 30.

Sky-Frame Pocket

When Sky-Frame Pocket is opened, the window panels slide into the wall so that living spaces are completely open, highlighting the magnificence of the interior architecture.

For technical details, see page 32.

Sky-Frame Inline

Sky-Frame Inline's elegant posts with a visible width of just 30 mm make it possible to create spectacular flush-fitted glass panels by connecting frameless fixed glass panels with sliding windows.

For technical details, see page 34.

Sky-Frame Gun

Security means quality of life. That is why Sky-Frame Gun features insulated security glass, reinforced frames and vertical profiles to protect against gunfire.

For technical details, see page 36.

Sky-Frame Sun

The Sky-Frame Sun solar shading assembly offers protection against heat and strong sunshine. The flat aluminium slats are suspended on thin guide cords that are easy to remove and fix back in place whenever necessary.

For technical details, see page 38.

Sky-Frame Hurricane

Sky-Frame's hurricane-tested, frameless sliding windows are some of the largest on the international market. They comply with the criteria for the authoritative standard of the industry – High Velocity Hurricane Zone (HVHZ) according to the Florida Building Code.

For technical details, see page 40.

Sky-Frame Color

Sky-Frame offers the window profiles with colourless anodisation. Alternatively, an individual colour from the RAL, IGP or DB colour systems can be defined for the powder coating or one of six anodized colours can be selected.

For technical details, see page 44.

SKY-FRAME CLASSIC



The name “Classic” not only evokes the timeless appeal of the rectilinear window system, but also highlights its historical significance as the first-ever Sky-Frame system. The sliding windows comprise insulating glass units with perimeter aluminium or glass-fibre-reinforced plastic (GRP) sections. Mounted in streamlined aluminium frames fitted flush with floor and ceiling, each unit rolls fluidly when operated. The system drainage for the flush assembly works either via recessed channel or is installed below the raised outdoor floor covering.

Vertical floor section

Floor connection (scale 1:4)

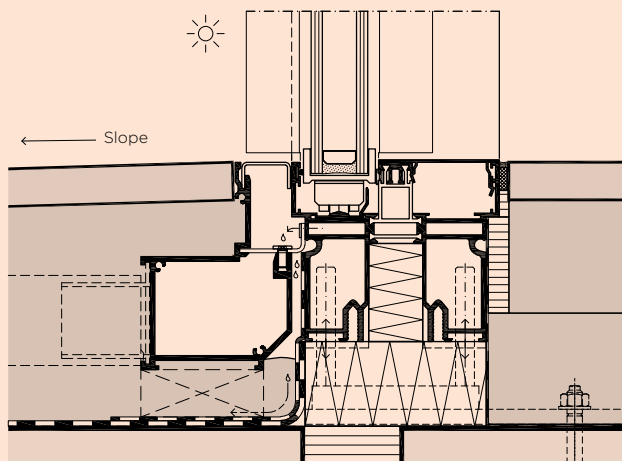
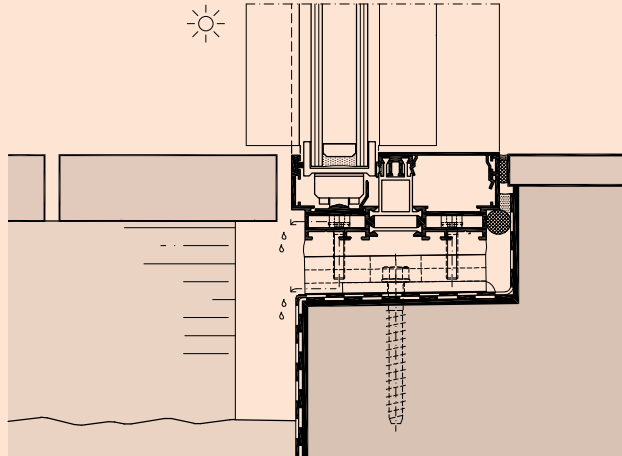

SKY-FRAME ARC



Sky-Frame Arc offers sliding glass panels to create curved fronts that lend organic, smooth contours to a residential space. The rounded glass units offer smooth running performance and can be equipped with an automatic drive. Meeting all Sky-Frame standards, the streamlined Arc system is an architectural feature that inspires endless additional design options.

Opening options

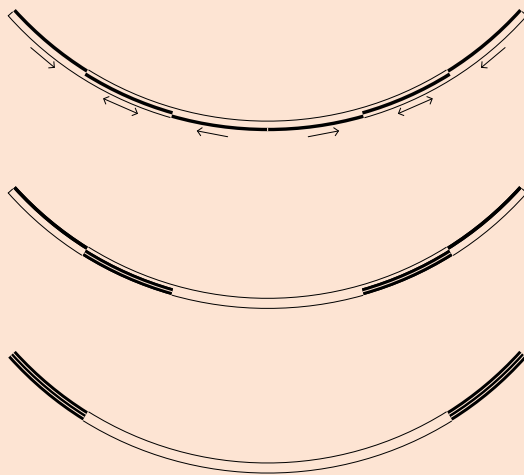

Straight edge (Classic) and curve (Arc) combination
Curve combination (Arc)

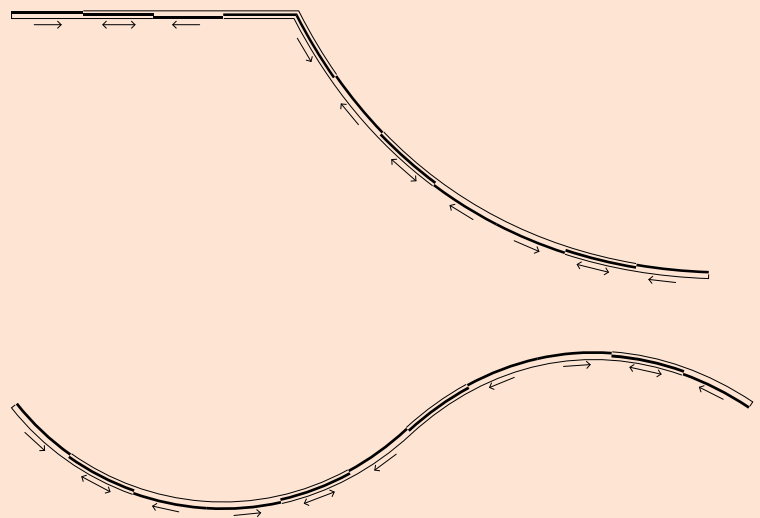

Feasibility

The following radii can easily be fabricated:
(other radii upon request)

Sky-Frame 2	Sliding elements	Fixed elements
two-track	R = 3.5 - 10 m	R = 2.5 - 10 m
three-track	R = 5.0 - 10 m	R = 5.0 - 10 m
Sky-Frame 3		
two-track	R = 3.8 - 10 m*	R = 2.5 - 10 m
three-track	R = 5.0 - 10 m*	R = 4.0 - 10 m

Sliding elements: width × height = max. 2.3 × 3.1 m

* Possible with electrical drive

SKY-FRAME SLOPE



Sky-Frame Slope sliding windows can either extend into the room or project outwards from the facade at an angle of up to 20°. The system meets all Sky-Frame standards while generating a distinctive spatial geometry. The bearing assembly is able to accommodate all vertical and horizontal forces, thereby achieving superior running performance. Regardless of the direction of the window, the drainage system meets all requirements for driving rain resistance.

Windows can tilt either inwards or outwards

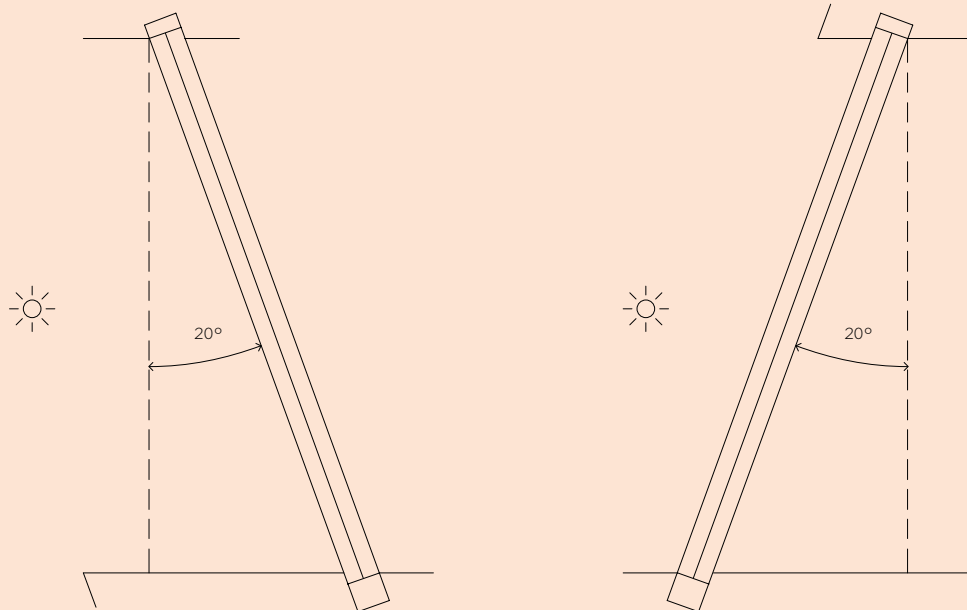

SKY-FRAME PIVOT



The Pivot system turns the simple act of opening a door into a creative experience: with a gentle push on the comfortable handle, the doors swing around the asymmetrically located axis, resulting in a temporary spatial structure. This could be the reason why Le Corbusier preferred these kinds of doors. The multipoint locking system guarantees safety and security, while the optional electromechanical locking system ensures additional ease of use.

Options

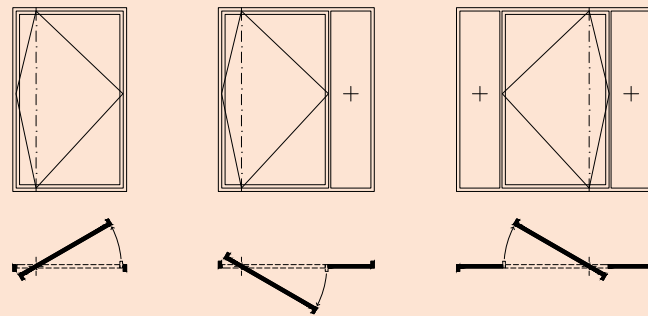

Vertical section

Ceiling and floor connection (scale 1:5)

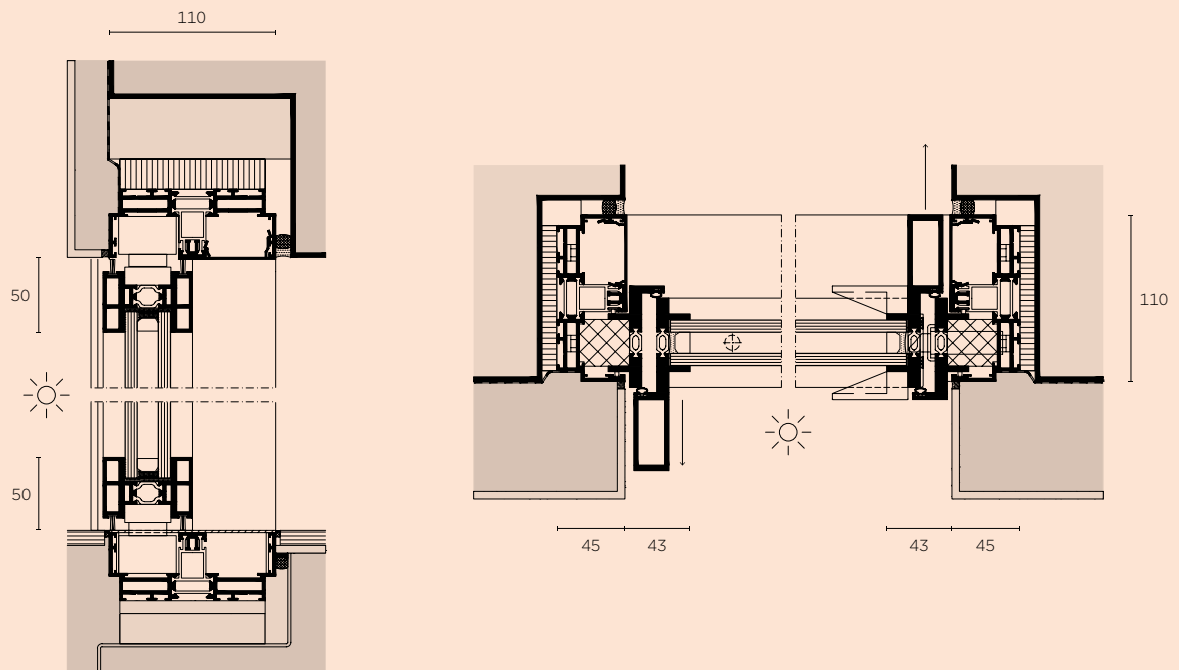

SKY-FRAME ORIGINAL



A feeling of vast, wide-open space, even when the windows are shut: the seamless transition between indoors and outdoors makes Sky-Frame Original a pioneer of modern design. The frameless windows are fully transparent thanks to a track system that is concealed in the floor — the result of 15 years of development. Compatible with all Sky-Frame products, Sky-Frame Original ensures that the temperature inside remains optimal while the heat and cold remain outside.

Vertical section

Ceiling and floor connection (scale 1:5)

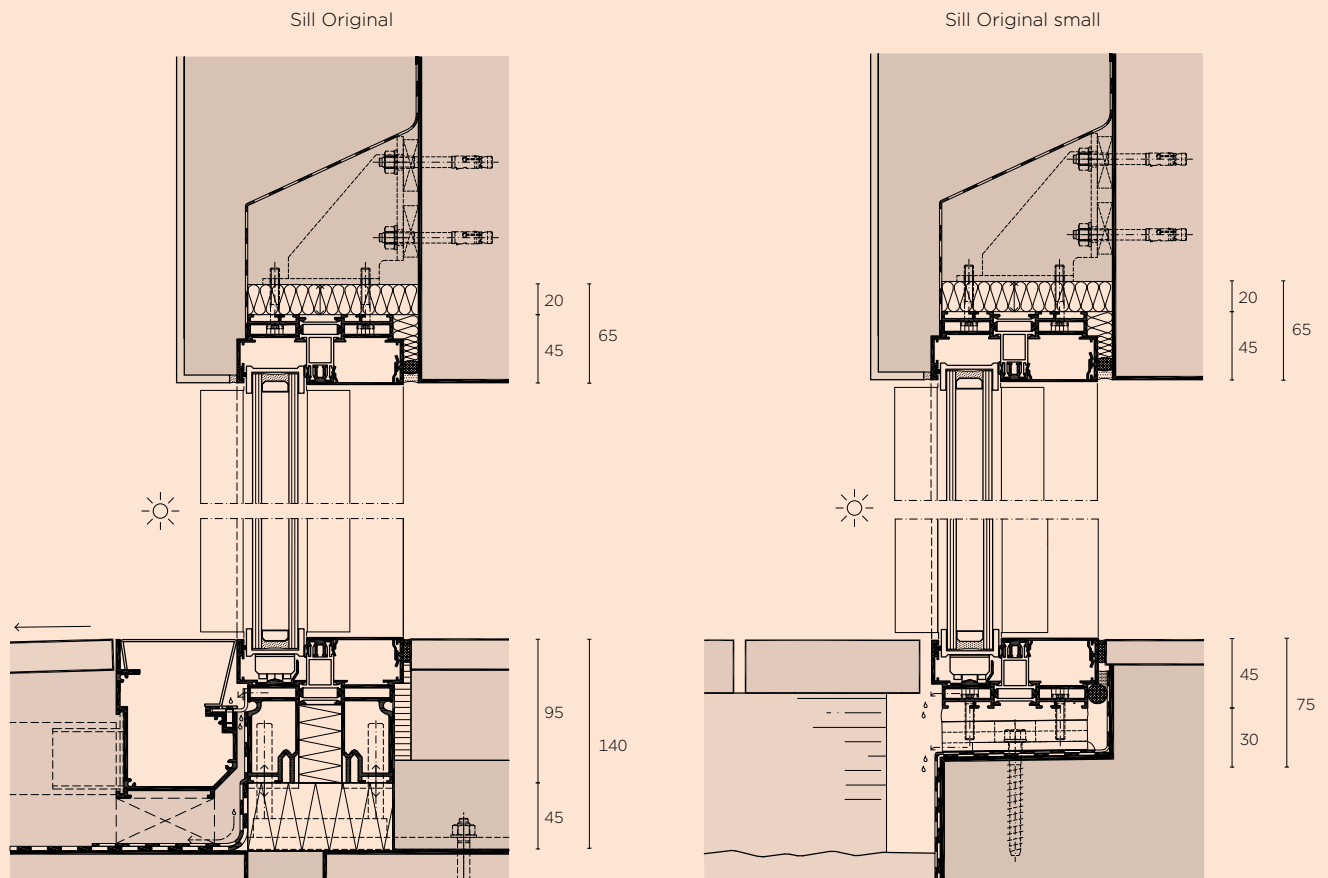

SKY-FRAME PLAIN NEW



What sets Sky-Frame Plain apart is the hidden transition between the inside and the outside that is flush-fitted with the floor. The sliding window glides along a narrow gap in the floor. The space between these tracks is covered by the same flooring as the interior of the room, which reinforces the feeling of a free-flowing transition between indoors and outdoors. As soon as the windows are open, this seamless transition becomes a pleasing experience. With its triple-glazed elements, Sky-Frame 3 with Option Plain is insulated to an optimum standard and can therefore also be installed in cold regions. Its innovative system layout makes maintenance and cleaning effortless, even in installed condition.

Vertical section, Sky-Frame 2 with Option Plain
Ceiling and floor connection (scale 1:5)

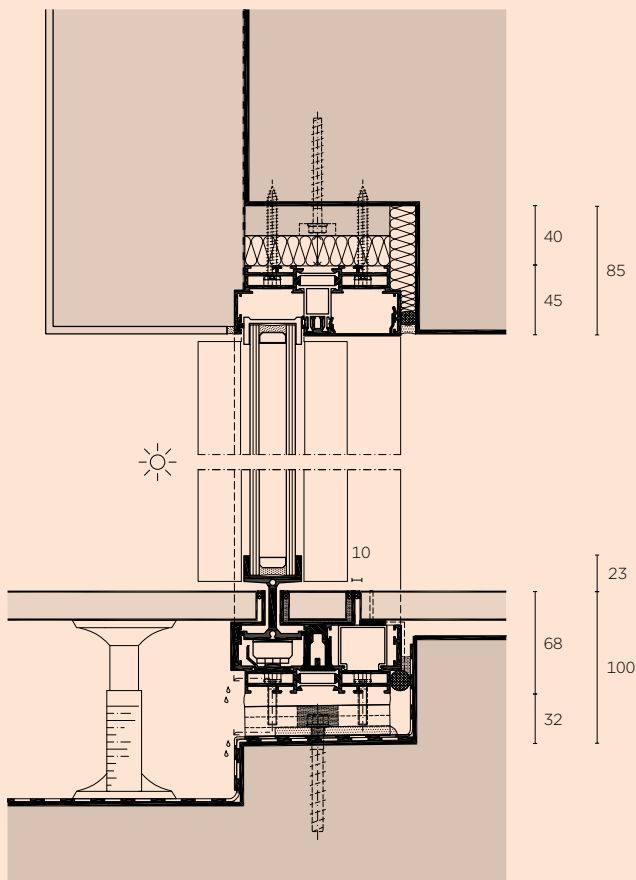

Vertical section, Sky-Frame 3 with Option Plain
Ceiling and floor connection (scale 1:5)

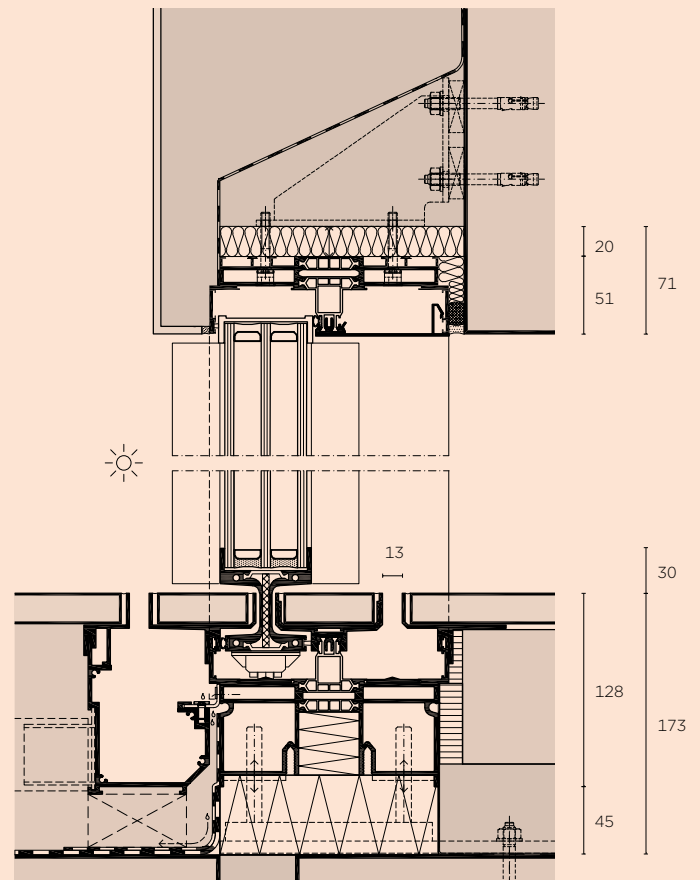

SKY-FRAME 1-3

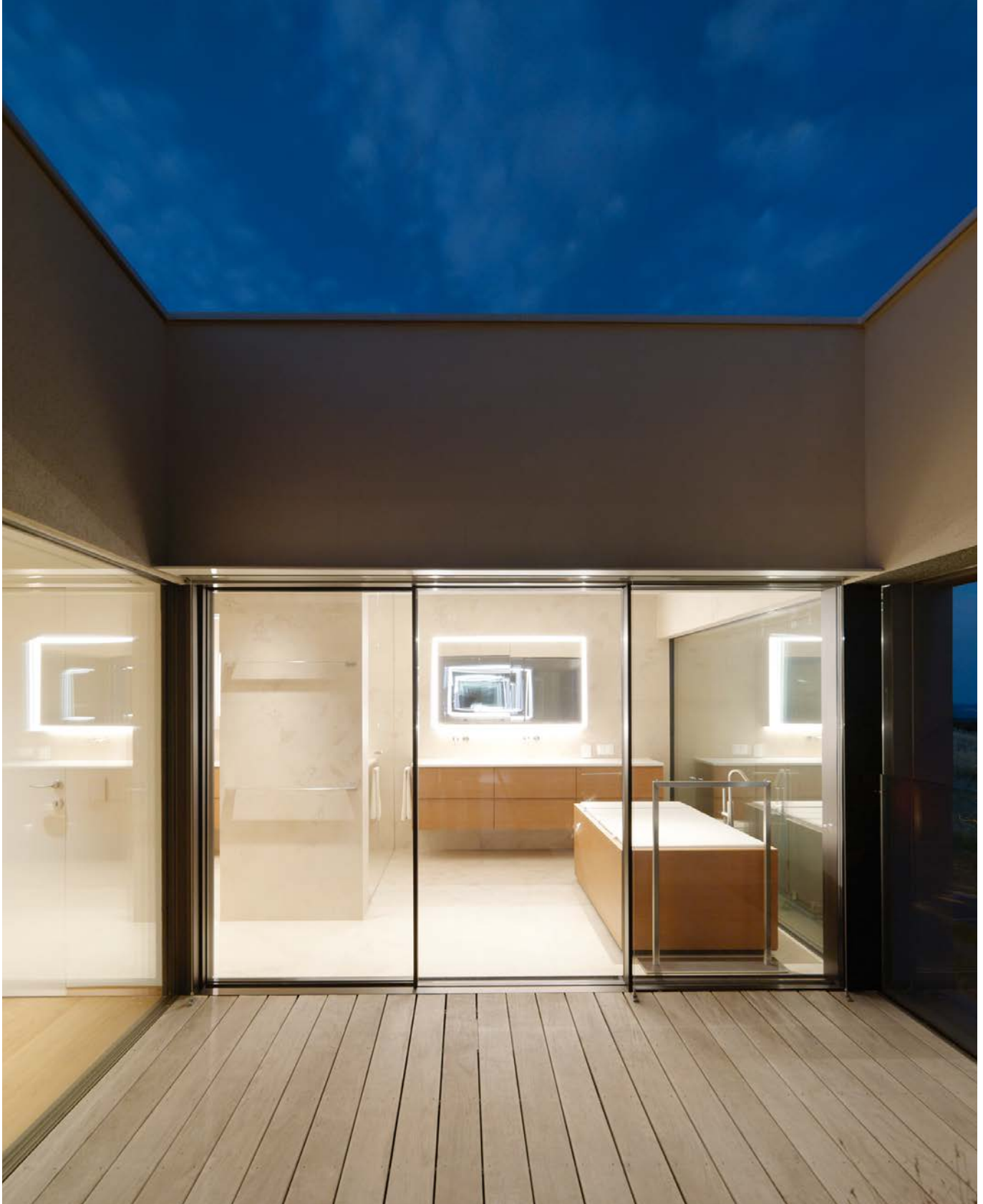

What are the requirements as regards thermal insulation, sound protection and stability against wind loads? Depending on the situation, single glazing will be sufficient or multiple glazing will be required. Sky-Frame 1-3 provides the right solution for every requirement.

Comparison (scale 1:2)

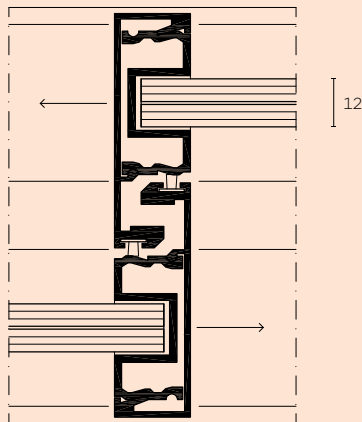

Sky-Frame 1
(glass 12 mm)

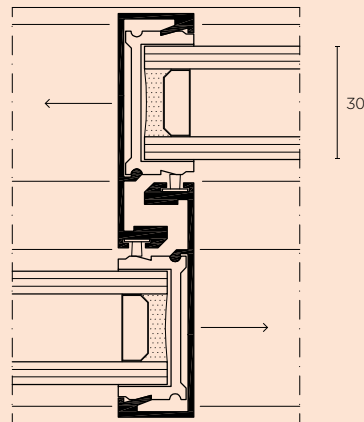

Sky-Frame 2
(glass 30 mm)

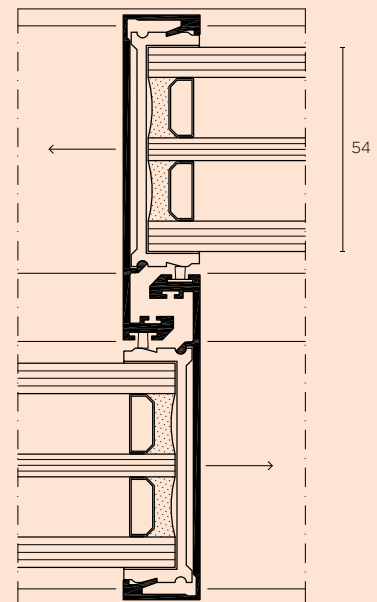

Sky-Frame 3
(glass 54 mm)

SKY-FRAME 1

The single-glazed Sky-Frame 1 units are suitable for applications without thermal insulation requirements. The system also incorporates special sliding seals that offer a high level of sound control.

Characteristics	Sky-Frame 1	Features
Panel sizes	3.2 m × 4 m (larger on request)	Sky-Frame Fly
Single glazing	12 mm	Sky-Frame Sun
Daylight / glass ratio	98 %	Sky-Frame Drive: single, telescopic (3+3 panels)
Watertightness to driving rain up to class	9A (EN 12208/EN 1027*)	Connection to alarm system:
Air permeability up to class	4 (EN 12207/EN 1026*)	- Position monitoring
Sound insulation up to	R _{w,P} 37 dB (EN ISO 717-1/EN ISO 10140*)	- Deadbolt monitoring

Profile options

S

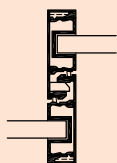

M

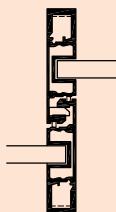

L

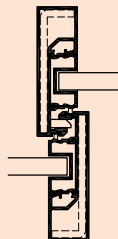

Horizontal section

Side wall junctions (scale 1:5)

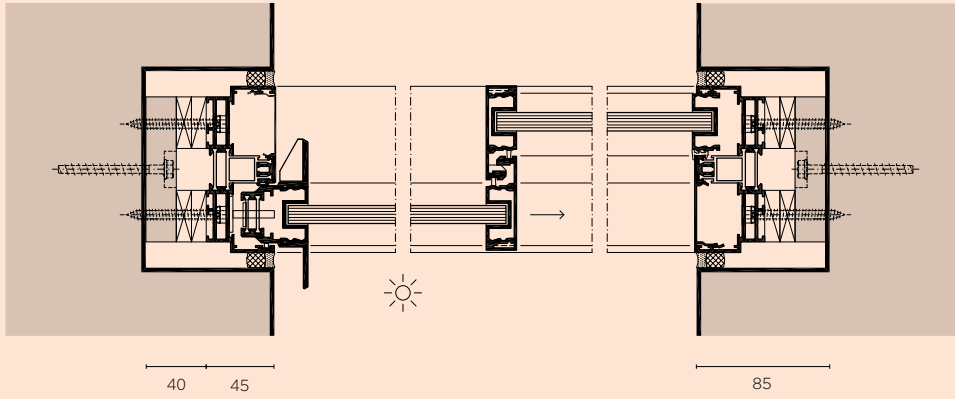

Vertical section

Floor and ceiling junctions (scale 1:5)

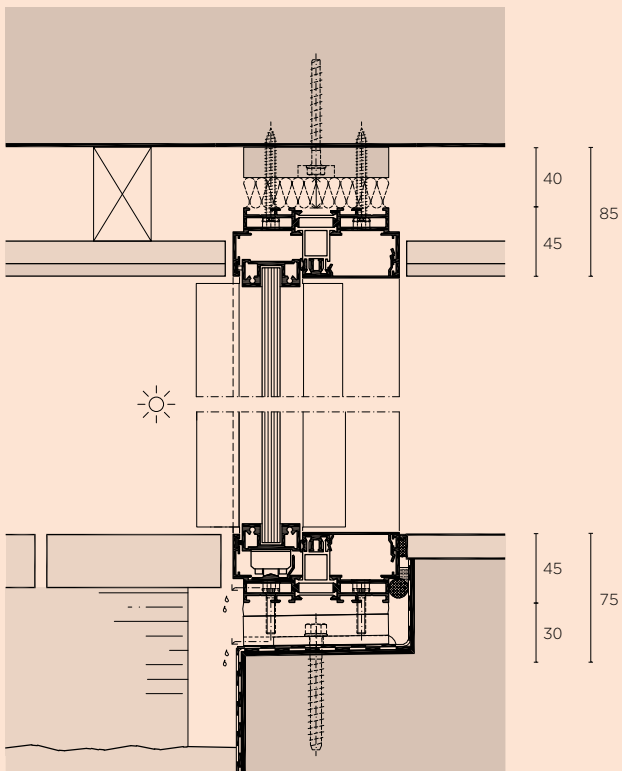

SKY-FRAME 2

The excellent sound and thermal control standards met by Sky-Frame 2 have made it the most popular Sky-Frame solution. The slim (only 30 millimetres thick) double-glazed insulating glass assembly has proved to be an outstanding performer in a wide range of climate zones.

Characteristics	Sky-Frame 2		Features
Calculation U_w (width × height 4.6 m × 3 m) acc. to norm	SIA 331	EN 10077	Sky-Frame Fly
Heat insulation value (glass $U_g = 1.1$)	$U_w = 1.25 \text{ W/m}^2\text{K}$	$1.36 \text{ W/m}^2\text{K}$	Sky-Frame Sun
Heat insulation value (glass $U_g = 1.0$)	$U_w = 1.15 \text{ W/m}^2\text{K}$	$1.27 \text{ W/m}^2\text{K}$	Sky-Frame Drive: single, telescopic (3+3 panels)
Panel sizes	2.3 m × 4 m (larger on request)		Sky-Frame Guard: - RC2 (EN 1628, 1629, 1630/EN 1627*)
Insulating glass (double glazing)	30 mm		Connection to alarm system: - Position monitoring - Deadbolt monitoring - Glass breakage sensor
Daylight / glass ratio	98%		
Watertightness to driving rain up to class	9A (EN 12208/EN 1027*)		
Air permeability up to class	4 (EN 12207/EN 1026*)		
Resistance to wind load up to class	C3 (EN 12210/EN 12211*)		
Anti-fall protection, category	A (DIN 18008-4)		
Sound insulation up to	$R_{w,P} 37 \text{ dB}$ (EN ISO 717-1/EN ISO 10140*)		
EPD	certified (EPD-SF-27.0)		

Values apply to Sky-Frame 2 with the Original option

Profile options

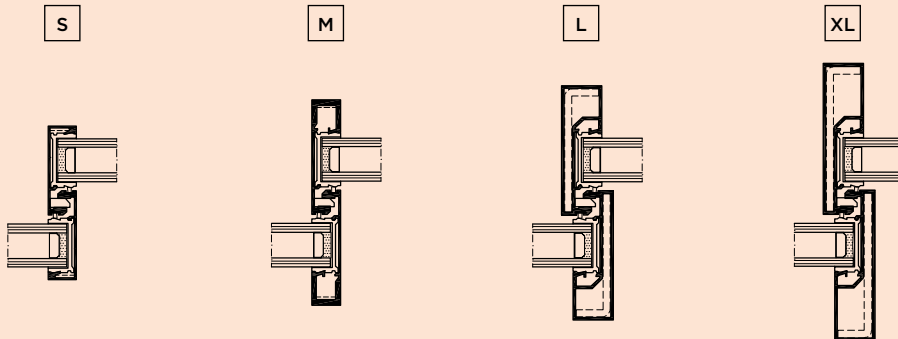

* Classification standard / test standard

Horizontal section

Side wall junctions (scale 1:5)
and temperature profile

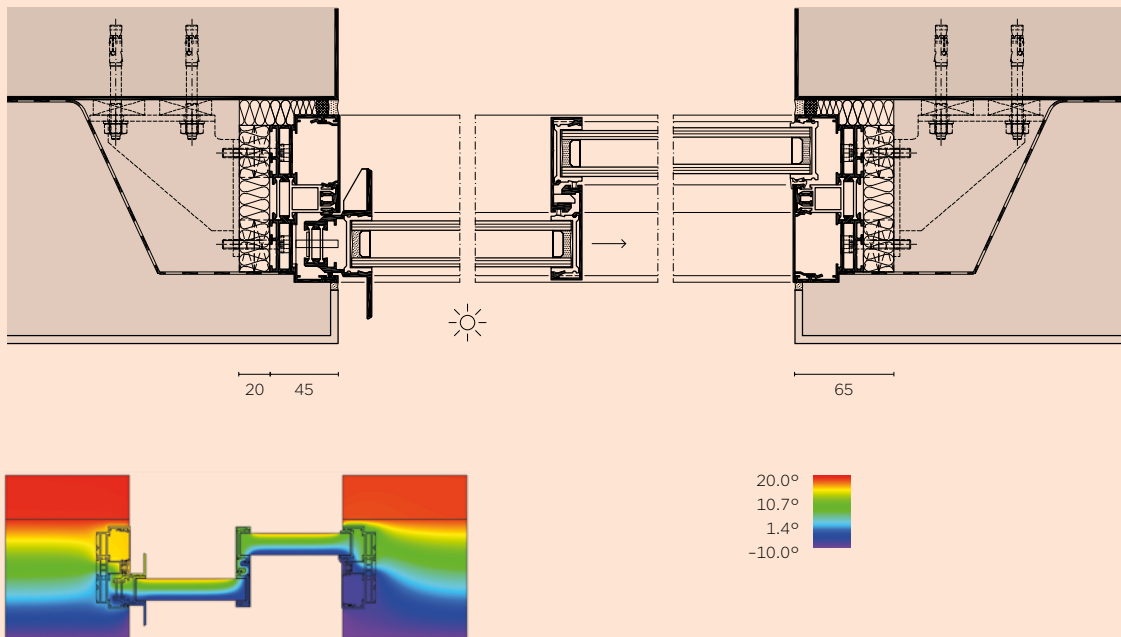
**Vertical section**

Floor and ceiling junctions (scale 1:5)
and temperature profile

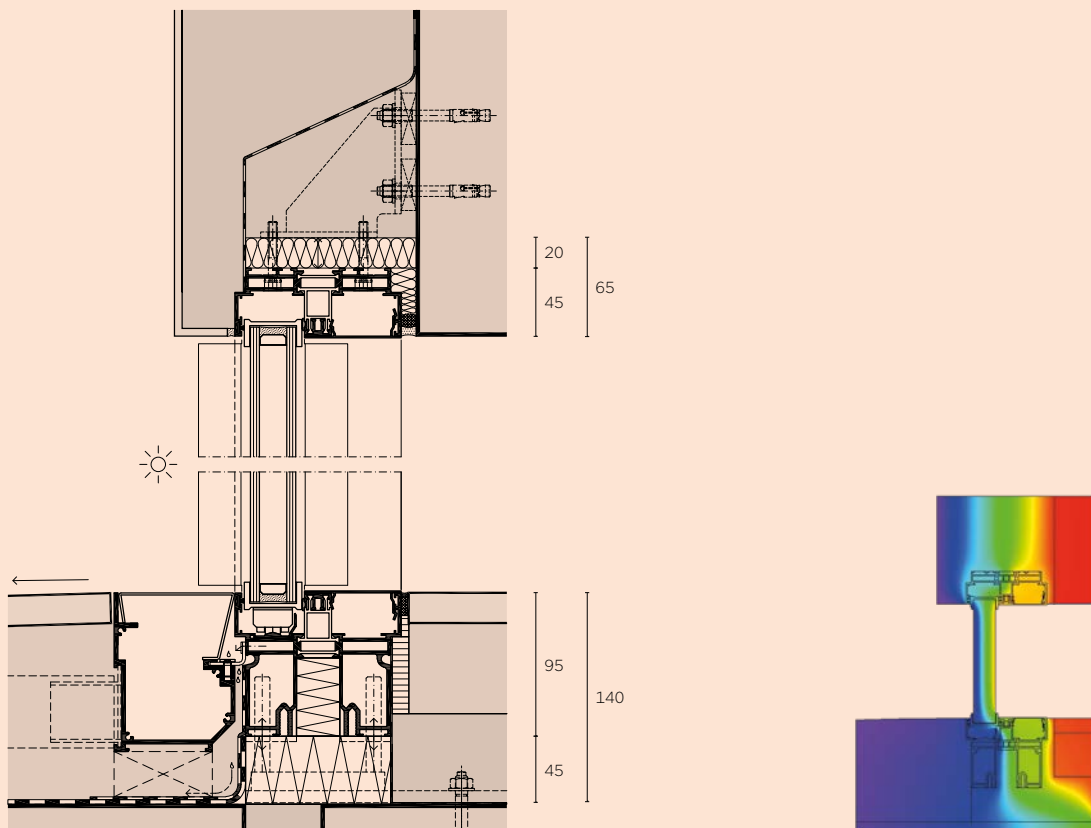

SKY-FRAME 3

The Sky-Frame 3 technology with its 54-millimetre thick insulating glass units meets the highest standards. The triple-glazed insulating panels offer extra stability and even greater resistance to wind loads.

Characteristics	Sky-Frame 3		Features
Calculation U_w (width × height 4.6 m × 3 m) acc. to norm	SIA 331	EN 10077	Sky-Frame Fly
Heat insulation value (glass $U_g = 0.6$)	$U_w = 0.75$ W/m ² K	0.87 W/m ² K	Sky-Frame Sun
Heat insulation value (glass $U_g = 0.5$)	$U_w = 0.66$ W/m ² K	0.78 W/m ² K	Sky-Frame Drive: single, telescopic (2+2 panels)
Panel sizes	2.3 m × 4 m (larger on request)		Sky-Frame Guard: - RC2 (EN 1628, 1629, 1630/EN 1627*)
Insulating glass (triple glazing)	54 mm		Connection to alarm system: - Position monitoring - Deadbolt monitoring - Glass breakage sensor
Daylight / glass ratio	98 %		
Watertightness to driving rain	6A (EN 12208 / EN1027*) up to E900 (EN 12208 / EN1027*) Configuration on request		
Air permeability up to class	4 (EN 12207/EN 1026*)		
Resistance to wind load up to class	C5 (EN 12210 / EN 12211*)		
Anti-fall protection, Category	A (DIN 18008-4)		
Sound insulation up to	$R_{w,P}$ 44 dB (EN ISO 717-1/EN ISO 10140*)		
MINERGIE module	certified (519,09)		
MINERGIE-P module	certified (519,12)		
EPD	certified (EPD-SF-27, 0)		

Values apply to Sky-Frame 3 with the Original option

Profile options

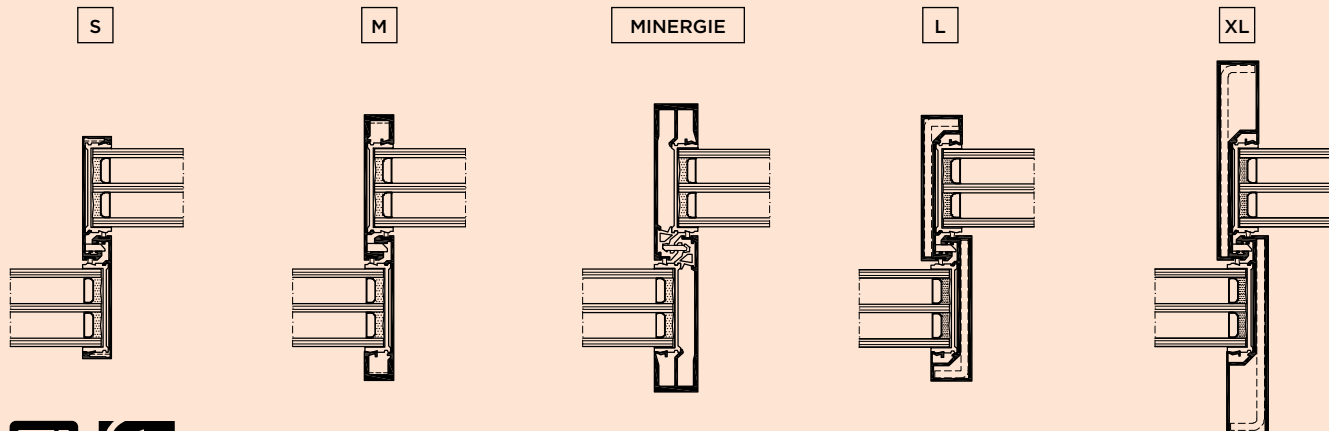

MINERGIE-P®
Mehr Lebensqualität, tiefer Energieverbrauch
Meilleure qualité de vie, faible consommation d'énergie

* Classification standard / test standard

Horizontal section

Side wall junctions (scale 1:5)
and temperature profile

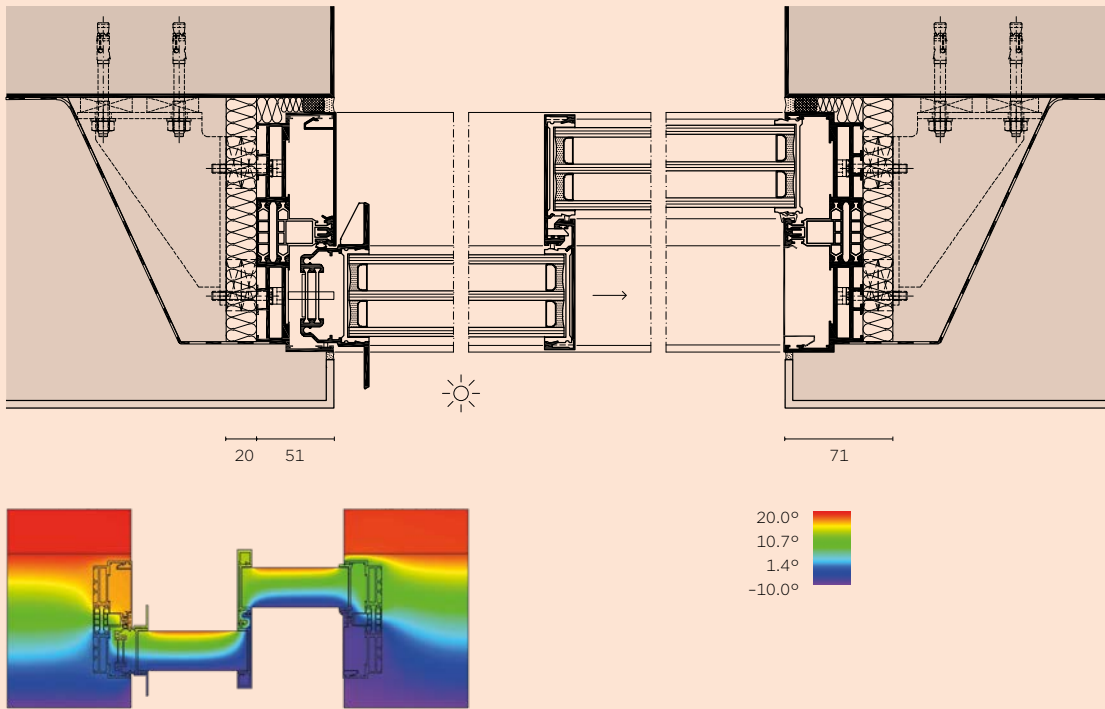

Vertical section

Floor and ceiling junctions (scale 1:5)
and temperature profile

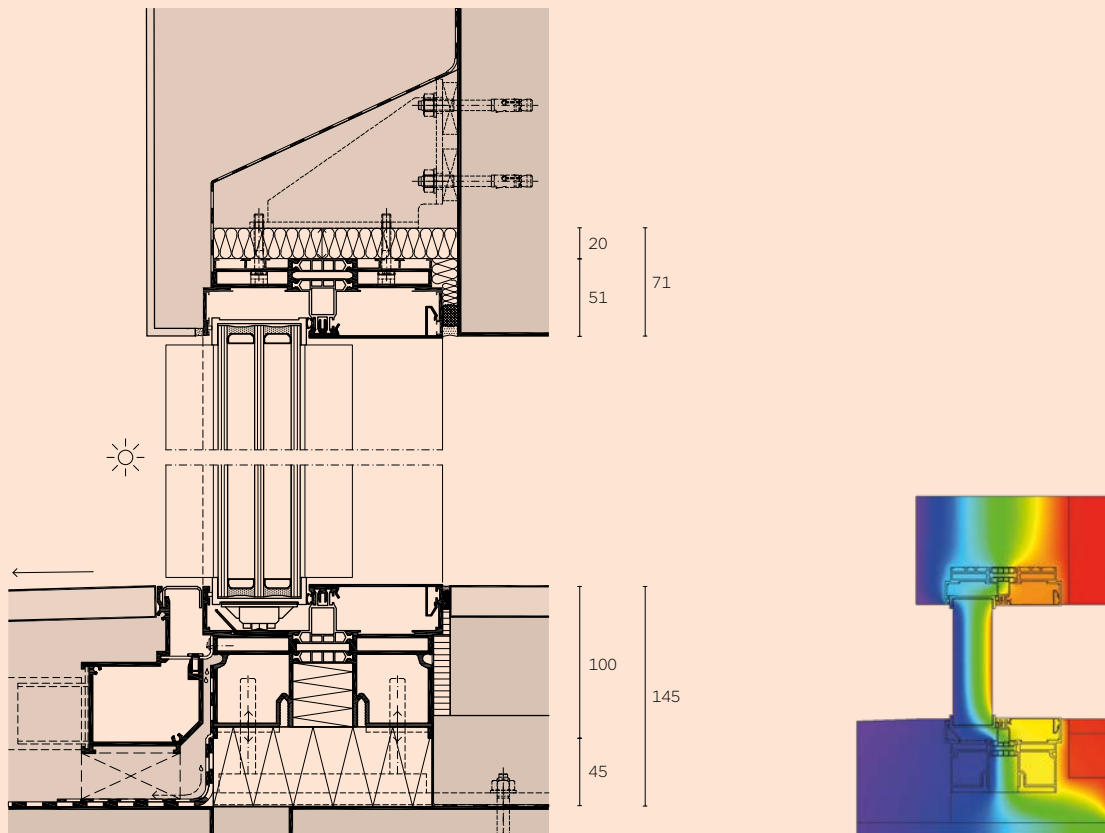

SKY-FRAME FLY

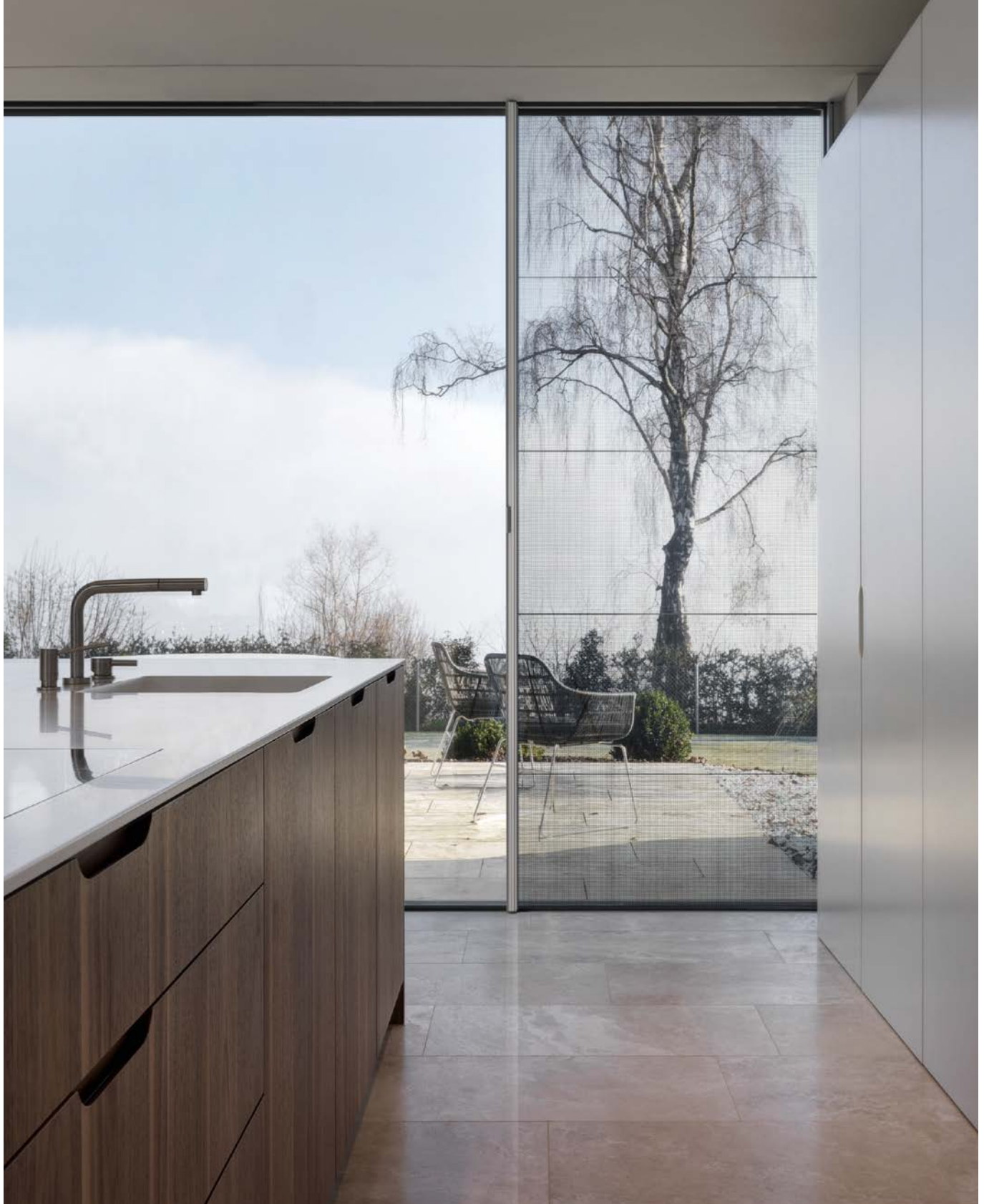

The Sky-Frame Fly insect screen is a minimalistic way to keep insects at bay. The frameless, pleated screen fully retracts into the frame when not in use. The combination of tear-resistant Vectran fiber tension cords and an integral system section guarantee maximum stability and weather resistance. Fly extends up to 1 m wide.

Horizontal section (scale 1 : 5)

Insect screen in closed position (top drawing)

Insect screen in open position (bottom drawing)

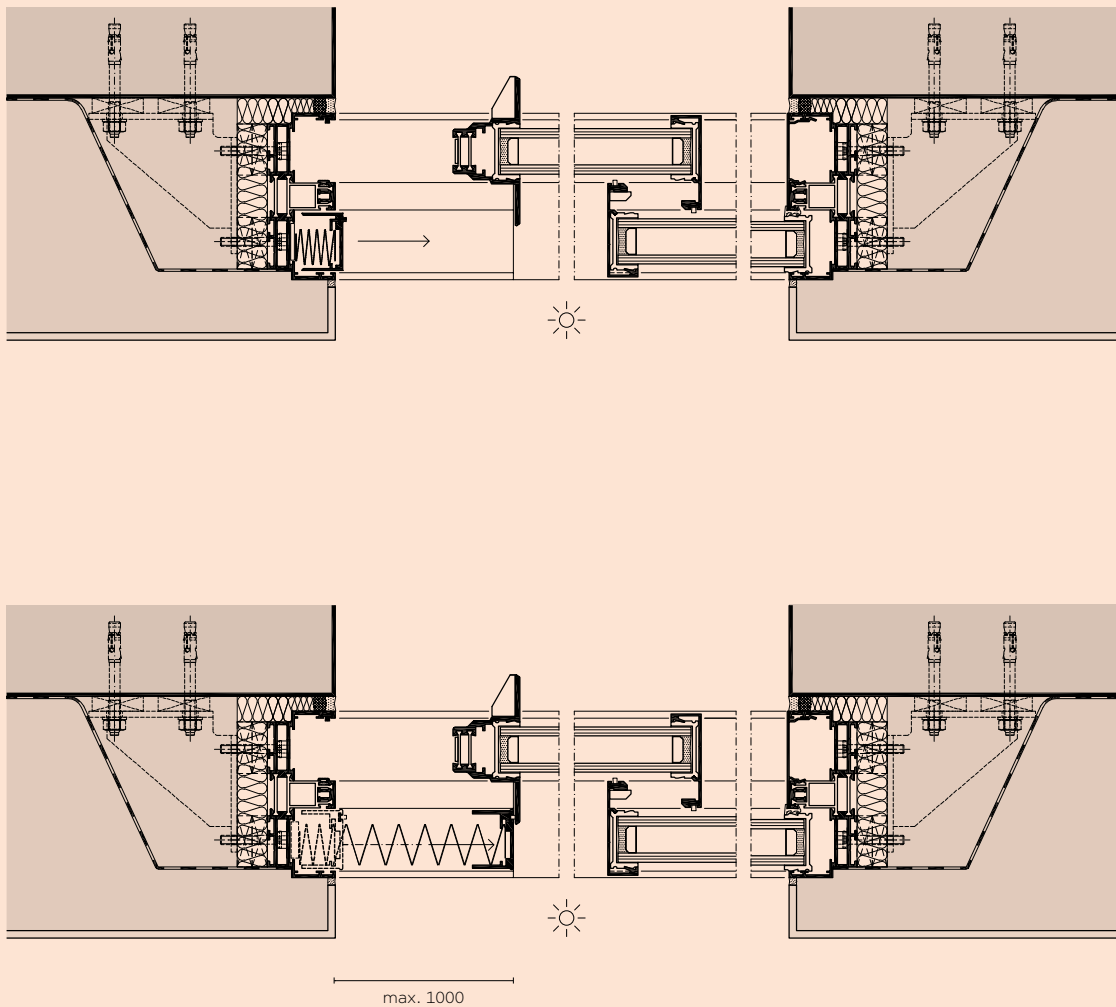

SKY-FRAME DRIVE



Sky-Frame Drive's electric drive facilitates simple and virtually noiseless operation of up to 6 (3+3) sliding panels at the press of a button. The drive is concealed in the ceiling section and allows the window panels to move automatically. The new Sky-Frame Touch control button is a convenient way to open and close sliding windows using the SI-1000 electric drive. Entire systems can be elegantly opened, closed or stopped at any point right at the window by applying gentle pressure on the rocker switch, which is unobtrusively integrated into the locking handle.

Side view

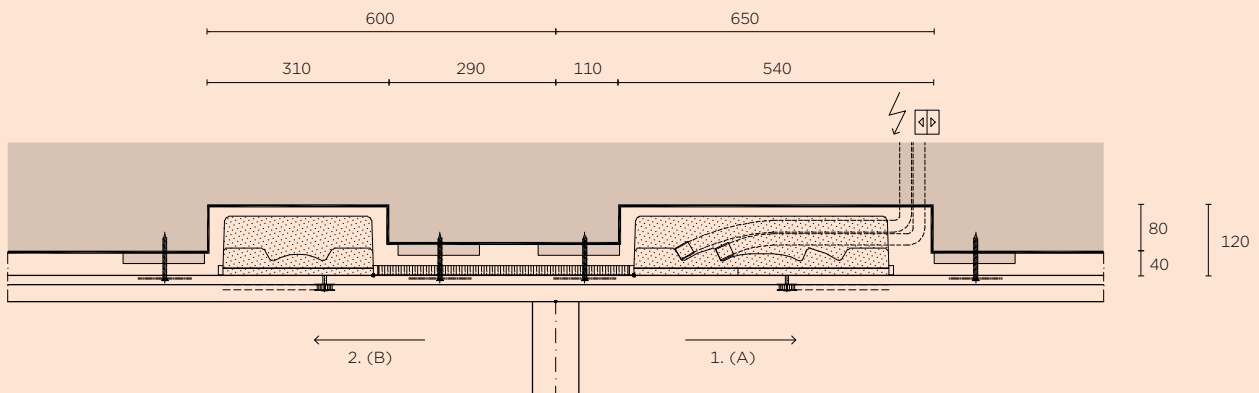

Opening options

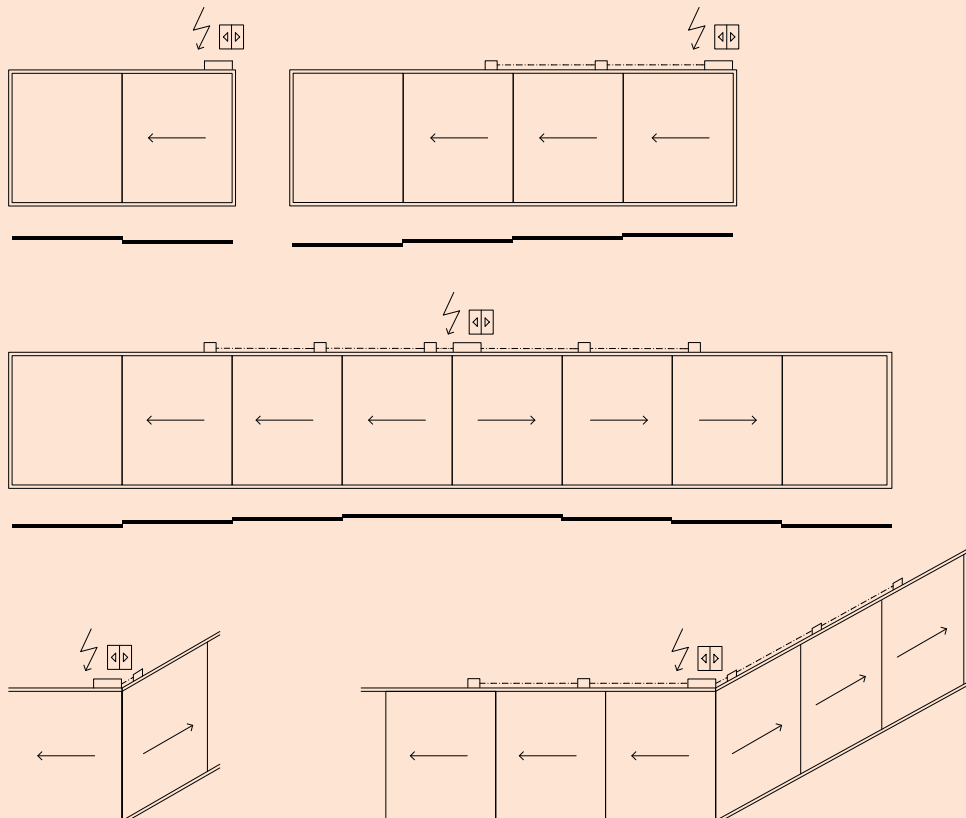

SKY-FRAME GUARD



Sky-Frame Guard offers outstanding burglar resistance thanks to an adhesive bond between the insulating glass assembly and the GRP sections, as well as a multi-point locking system. Various additional components are available to meet further security requirements.

Electronic components

- Position monitoring (leaf)
- Deadbolt monitoring (lock)
- Glass breakage sensor (alarm loop)

These three security parameters can be electronically monitored by alarm sensors concealed in the unit, and the status information can be transmitted to a burglar alarm system.

Mechanical components

The Sky-Frame 2 and Sky-Frame 3 technologies have been inspected by ift Rosenheim and comply with the following anti-burglary protection class:
RC 2 (WK2) (EN 1628, 1629, 1630/EN 1627)
RC 4 + PAS24: on request

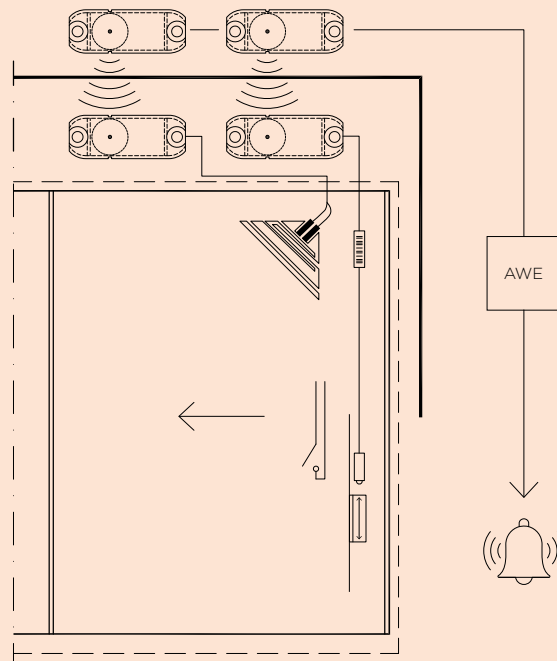

SKY-FRAME POCKET



With the Sky-Frame Pocket solution, rooms can be completely opened up without any visible glass leaves. The sliding panels are recessed and hidden away from sight. Additional features such as Sky-Frame Drive (electrically driven opening and closing) are also available.

Horizontal section

Side wall junction (scale 1:5)

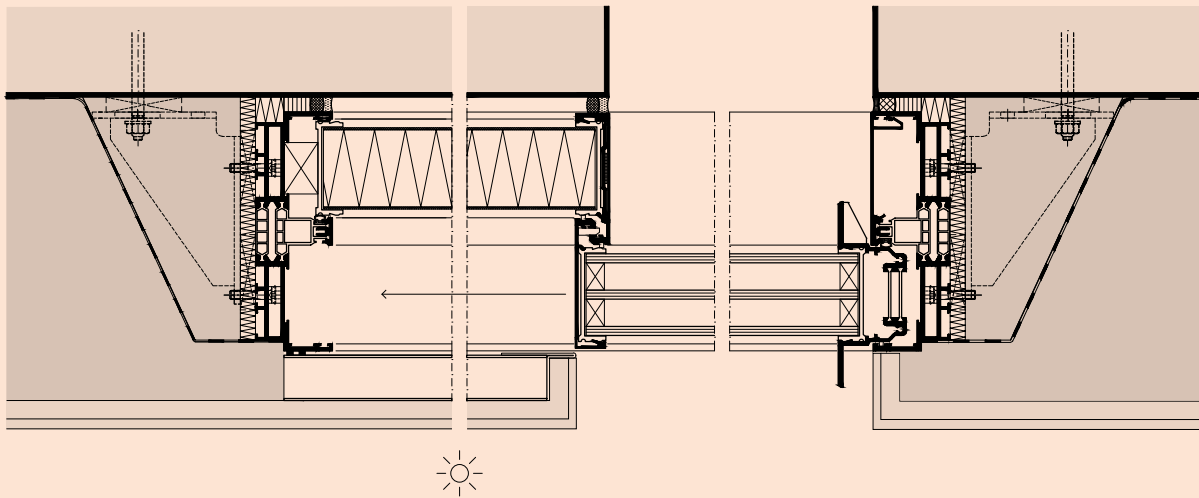

Opening options

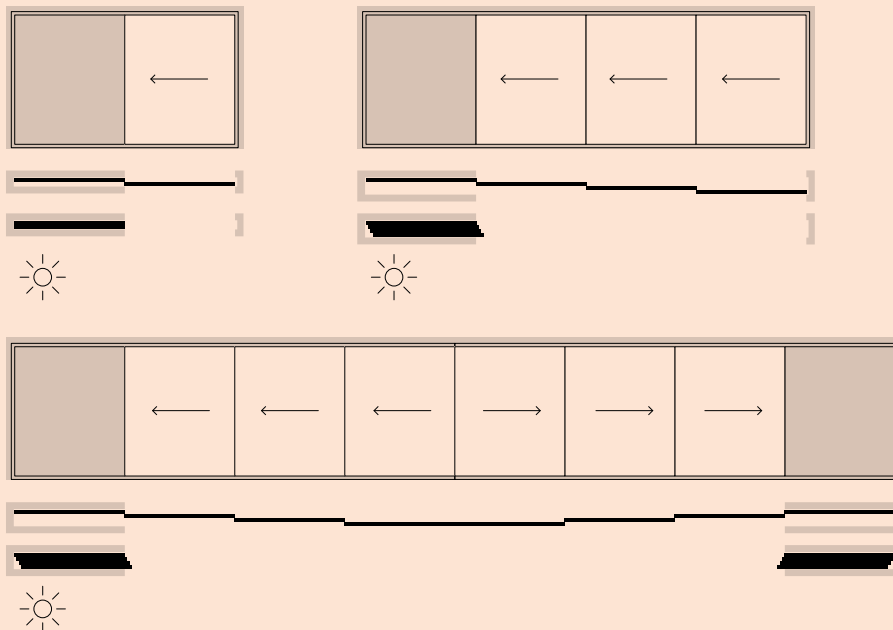

SKY-FRAME INLINE



The Sky-Frame system is supplemented by elegant filigree posts, which has a minimal visible width of just 30 mm. It is available in three installation depths (66/90/110 mm) and can be reinforced with up to four steel profile inserts for higher static specifications. Frameless fixed glass panels can therefore be combined with sliding windows over large areas, forming a flush, continuous glass membrane.

Sky-Frame 2

Double glazing (scale 1:5)

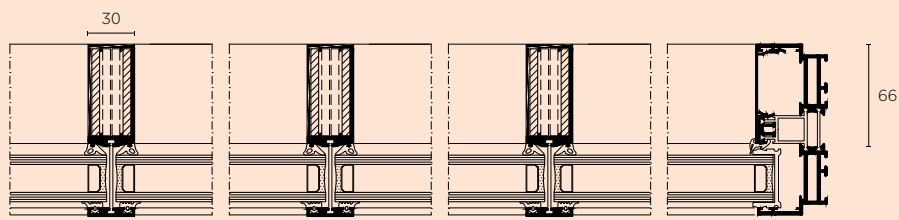
**Sky-Frame 3**

Filigree post combined with sliding panel (scale 1:5)

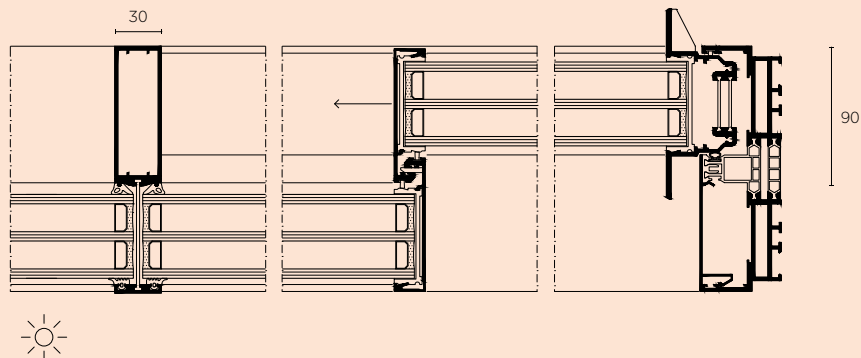

SKY-FRAME GUN

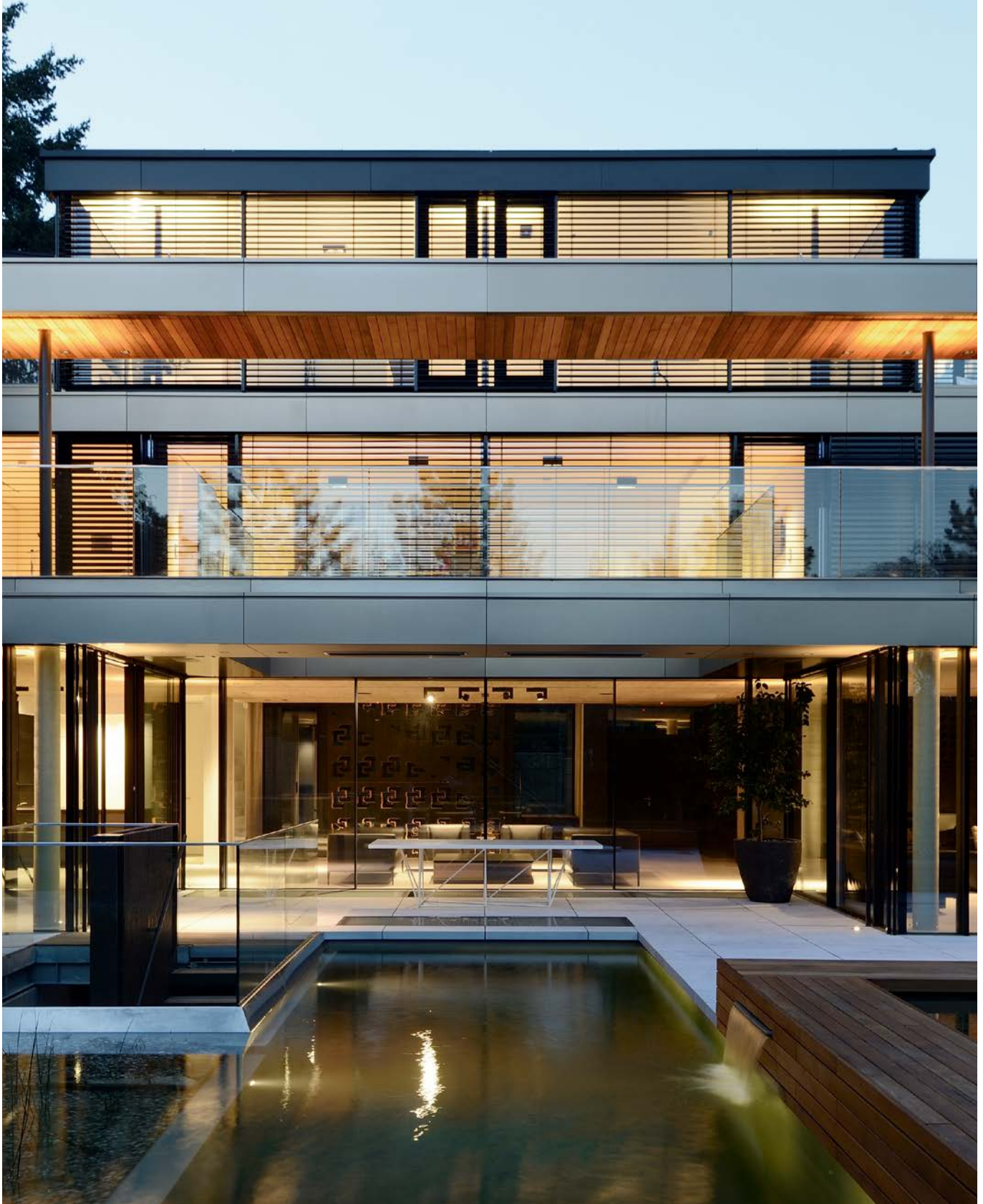

With special insulated security glass (2-IG with bullet resistant glass), reinforced frames, vertical profiles and defined building joints, Sky-Frame 3 Gun ensures optimal protection from gunfire.

The Swiss Federal Office for Defence Procurement armasuisse has rated Sky-Frame 3 Gun as FB4, NS (.44 Magnum, no spall).

Bullet resistance

Reinforced profiles with bulletproof glass (scale 1:5)

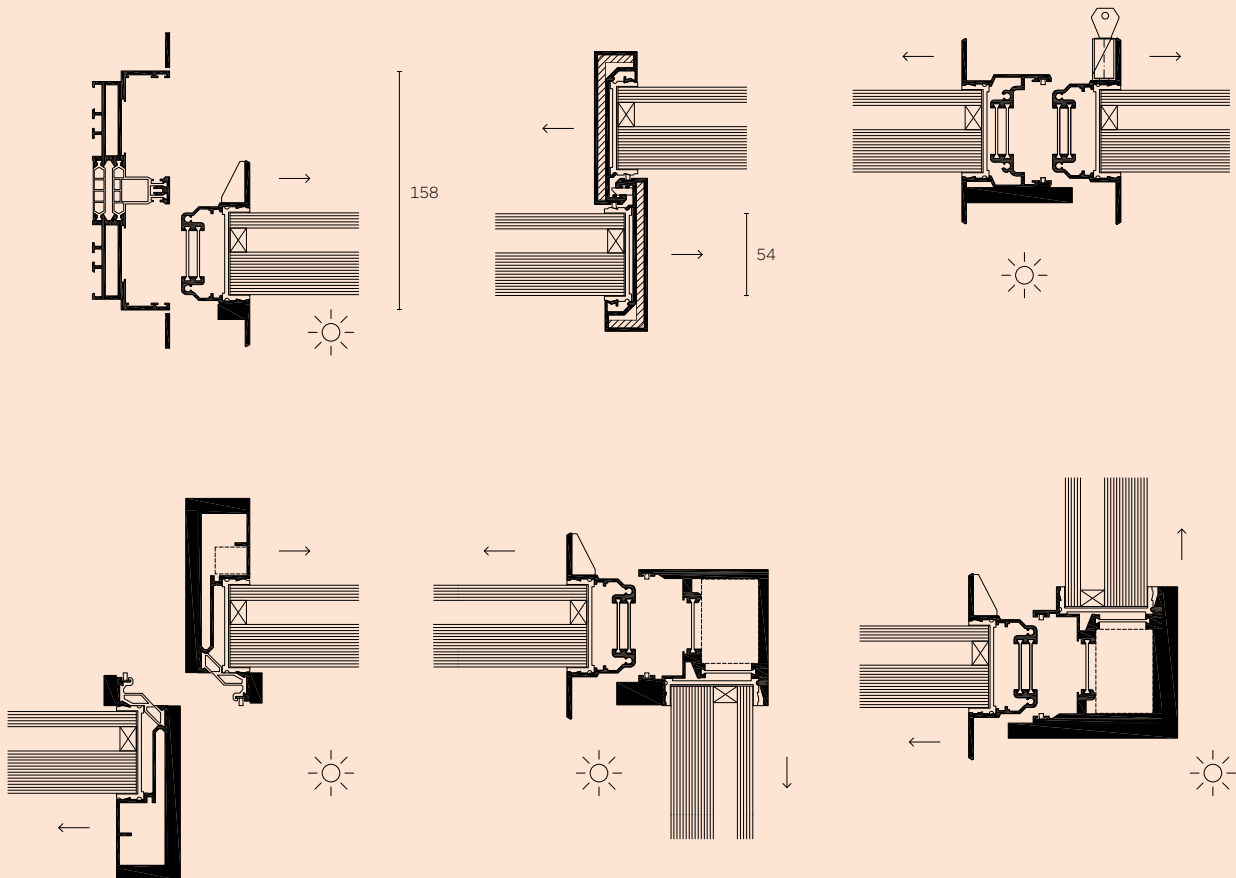

SKY-FRAME SUN

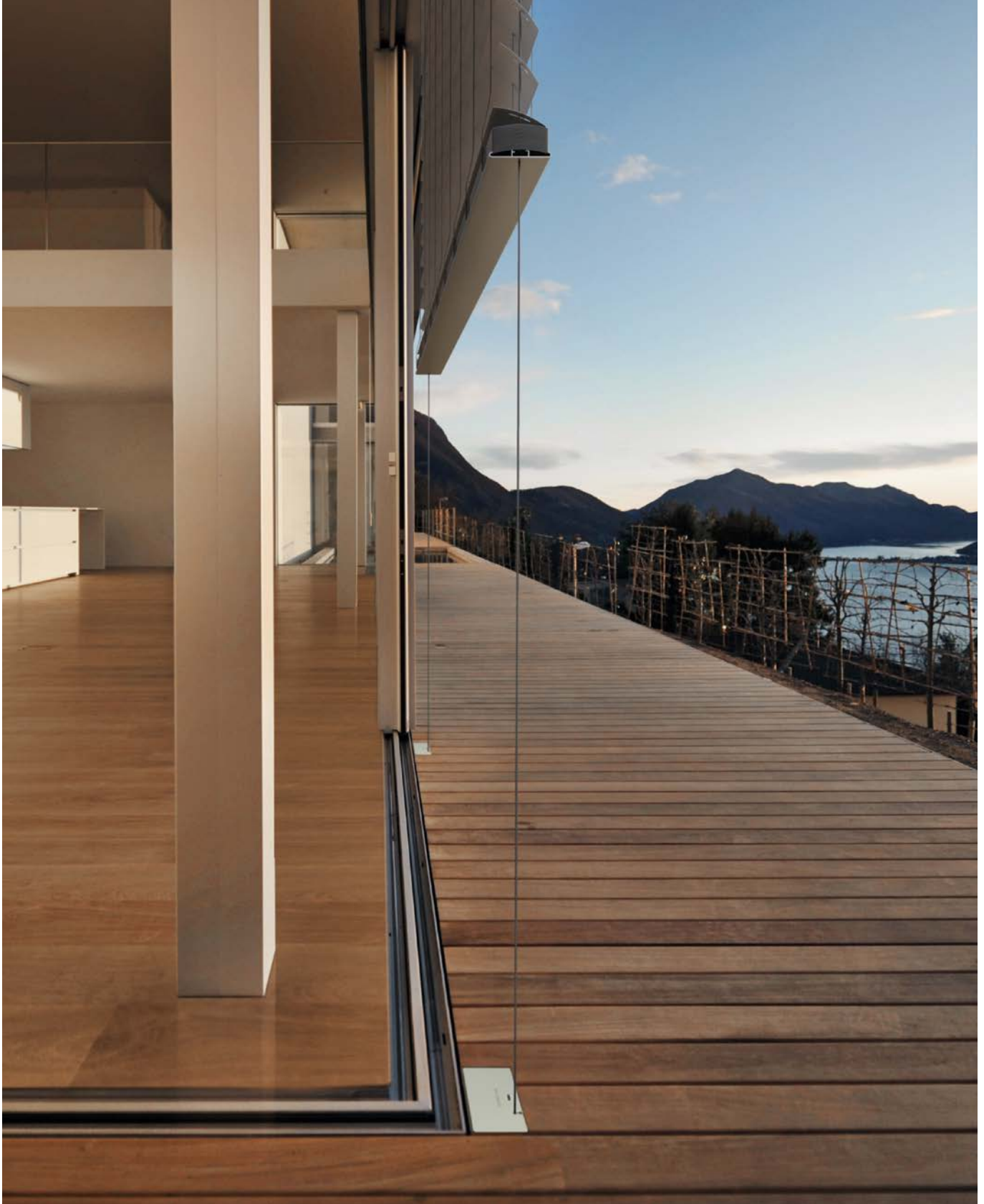

The Sun venetian blind system with its flat, 80 mm wide aluminium slats offers the perfect solar shading solution for the elegant Sky-Frame sliding windows. Slats that measure up to 3 m width and with a maximum height of 4 m are suspended on plastic-sheathed guide cords. The Sun box is recessed into the floor and the winding mechanism in the blind box facilitates swift dismantling of the guide cords to create an unobstructed opening as well as their subsequent reinstallation.

Horizontal section

(scale 1:10)

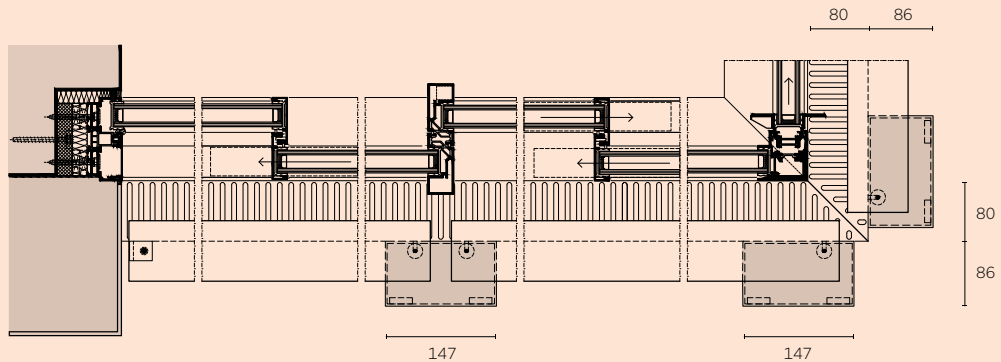

Vertical section

(scale 1:10)

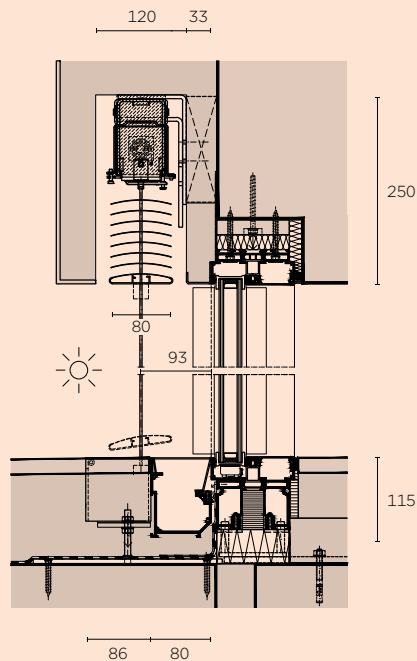

SKY-FRAME HURRICANE



Sky-Frame Hurricane sliding doors have exceeded the most stringent hurricane impact tests, and are compliant with the High Velocity Hurricane Zone (HVHZ) criteria as defined by the Florida Building Code – considered to be the gold standard in the industry. Fulfilling the requirements of Miami- Dade County, Sky-Frame’s 2.3 m × 3.5 m panels are one of the largest hurricane-rated frameless sliding doors on the world market. The values of 1,200 Pa (25 psf) reached during the driving-rain tests are among the world’s highest, and greatly contribute to the water-resistance of the windows. The sliding doors can be motorized or manually operated with a wide range of opening options and a slim 29 mm sight line offers an unbounded spatial experience for exceptional architecture. Multi-tracks allow an unlimited number of sliding doors to be installed next to each other.

SKY-FRAME HURRICANE

Characteristics	Sky-Frame 3 Hurricane	Sky-Frame 3 Hurricane	Features
Design pressure	3.1 kN/m ² 65 psf	3.6 kN/m ² 75 psf	Sky-Frame Pocket
Sliding or fixed panel <small>(max. width × height)</small>	2311 mm × 3505 mm *7'7" × 11'6"	1524 mm × 3505 mm *5' × 11'6"	Sky-Frame Fly
Max. panel area <small>*all possible dimensions on request</small>	87 ft ² 8.1 m ²	75 ft ² 6.9 m ²	Sky-Frame Drive
Insulating glass (double glazing)	40.5 mm 1 5/8" LSG-TSG 6/6.6 SGP / 12 / LSG-TSG 6/6.6 SGP		Sky-Frame Guard: Connection to alarm system: - Deadbolt monitoring - Position monitoring
Watertightness to driving rain up to	1200 Pa (25 psf)		
Rating <small>(Tas 201/202/203)</small>	HVHZ, wind zone 4, large and small missile impact		
NFRC	available		

Configuration

Number of tracks	2-4
Number of panels	no limit
Configuration restrictions	no slider on the inner track
Steel-reinforced labyrinth	available
Centre opening offset	available
Centre opening on same level	available
Edge opening	available
Corner opening	not available
Fixed corner glazing	not available
Inline	not available

Institute / Authority



Horizontal section
(M 1:5)

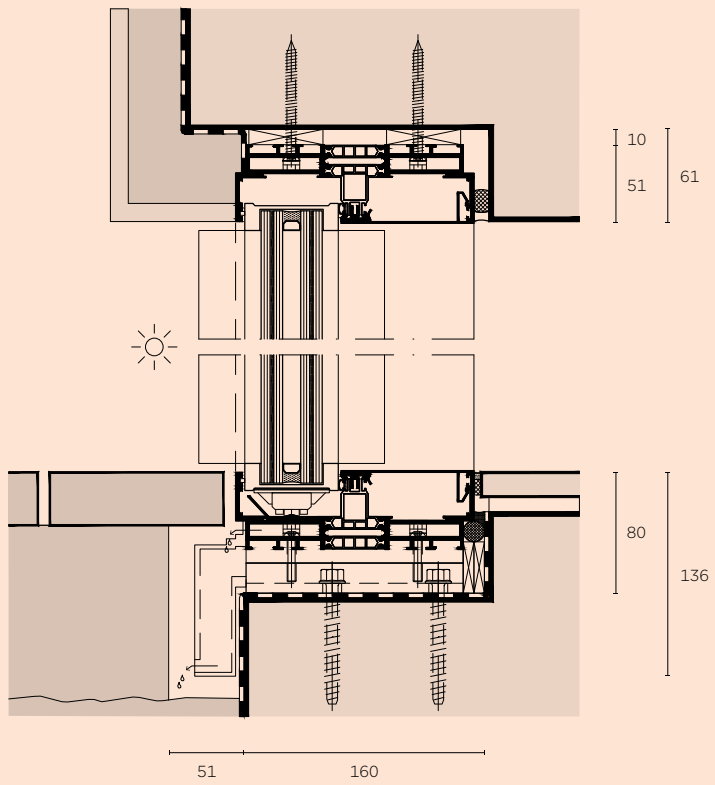

Vertical section 2 track
(M 1:5)

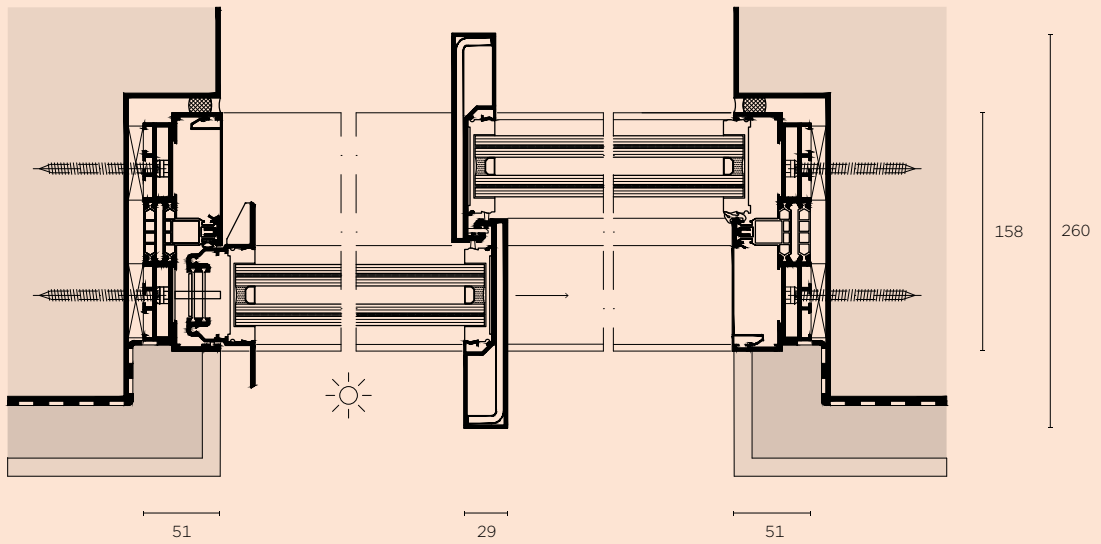

SKY-FRAME COLOR



Create your own Sky-Frame sliding windows: choose the profile colour and we will bring your vision to life. The sliding-window system you choose will be assembled by highly experienced glaziers, metalworkers and coating specialists who work with real diligence and have a passion for what they do.

Unique colours

In addition to the anodized colours shown below, you can choose any colour from a range of palettes (RAL, IGP, DB) for the powder coating.



Anodized colours



E6 EV1
colourless anodized
standard



Colinal 3115
chemically matted
surcharge

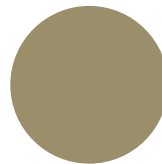

Colinal 3145
chemically matted
surcharge

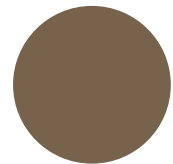

Colinal 3165
chemically matted
surcharge

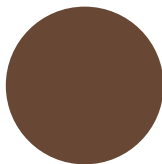

Colinal 3175
chemically matted
surcharge

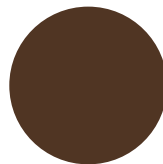

Colinal 3178
chemically matted
surcharge

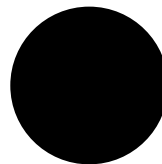

Colinal 3180
chemically matted
surcharge

SWISS MADE.



The spectacular frameless glass panels and flush transitions allow inside and outside to merge seamlessly into one another to form a living space. Ever since the first Sky-Frame window was installed in 2002, the Swiss company has helped to make more than 8000 individual lifestyle dreams come true and create innovative living spaces around the world.

Sky-Frame develops and manufactures all of its premium products in Switzerland and regularly wins renowned design and business awards. Together with universities and research institutions, Sky-Frame continuously drives forward new solutions for ambitious living concepts.

Sky-Frame's immense passion and in-depth understanding of architecture, spatial design and technology has made it the leading international supplier of frameless sliding window systems.



WE LOVE WHAT WE DO. REFERENCES.



1



2



3



4



5



6



7



8



9

1, 2 Wohnhaus Freundorf, Austria. Architecture: Project A01, Austria. 3 Vitrahaus, Germany. Architecture: Herzog & de Meuron, Switzerland.
4 Villa in Utrecht, Netherlands. Architecture: Zecc Architects BV, Netherlands. 5 Penthouse in New York, USA. Architecture: UNStudio, Netherlands.
6 Haus G, Germany. Architecture: ATP Sphere, Netherlands. 7 Villa Kavel 01, Netherlands. Architecture: Studioninedots, Netherlands.
8 Orum, USA. Architecture: SPF:architects, USA. 9 Caversham, United Kingdom. Architecture: Gregory Phillips Architects, United Kingdom.

Head Office

Sky-Frame Switzerland
www.sky-frame.com

Sky-Frame Branches

Austria, Vienna
Belgium, Antwerp
Great Britain, London
Italy, Milan
USA, Los Angeles

Sky-Frame Partners

Australia	Monaco
Austria	Netherlands
Belgium	Norway
Canada	Peru
China	Philippines
Croatia	Poland
Czech Republic	Portugal
Denmark	Qatar
France	Russia
Germany	Singapore
Greece	Slovenia
Hong Kong	Slovakia
Hungary	South Africa
India	South Korea
Ireland	Spain
Israel	Sweden
Italy	Switzerland
Japan	Taiwan
Latvia	Thailand
Liechtenstein	Ukraine
Lithuania	United Arab Emirates
Luxembourg	United Kingdom
Mexico	USA

For further details, please visit our website:
www.sky-frame.com

Architecture

Will Architektur, Austria (cover page, page 18)
Bembé und Dellinger Architekten, Germany (page 6)
Loek Stijnen, Lab 32 Architecten, Netherlands (page 8)
Sergio Caverio, Switzerland (page 14)
Tec Architecture, Switzerland (page 26)
Peter Pichler Architecture, Italy (page 28)
Biehler Weith Associated, Germany (page 30)
Gus Wüstemann, Switzerland and Spain (page 32)
Zoran Bodrozic, Austria (page 36)
Peter Kunz, Switzerland (page 46)

Copyright

© 2021 Sky-Frame

Concept and Design

STUDIO NEO, Switzerland

Text

Jung von Matt, Switzerland

Photography

Paul Ott, Austria (cover page, page 18)
Brigida González, Germany (Seite 6, 14, 30, 48)
René de Wit, Netherlands (page 8)
Bruno Helbling, Switzerland (page 26, 32)
Oskar da Riz, Italy (page 28)
Robert Niederl Photography, Austria (page 36)
Claudia Luperto, Switzerland (page 46)
Mel Yates, United Kingdom (page 48)
Matthew Momberger, USA (page 48)
Cornbread Works, Netherlands (page 48)
Tom Bisig, Switzerland (page 48)
Peter Cuypers, Netherlands (page 48)
Iwan Baan, Netherlands (page 48)

**A VIEW,
NOT A
WINDOW.**